

FUDA2-S1x11 Series Panel PC

(10.4"/12.1"/15"/17"/19")

Slim and Fan-free 5-wire Resistive Touch Panel PC
Powered by Intel® Atom™ Bay Trail Quad-core Processor

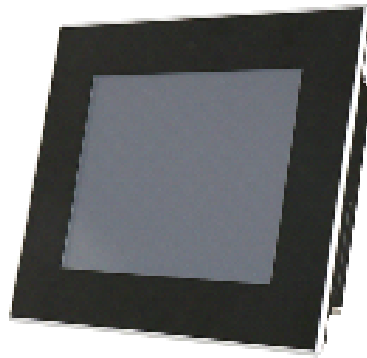

User's Manual

Version 1.4

Copyright © Portwell, Inc., 2015. All rights reserved.
All other brand names are registered trademarks of their respective owners.

Table of Contents

How to Use This Manual

Chapter 1 System Overview	1-1
1.1 Introduction.....	1-1
1.2 Check List	1-2
1.3 Product Specification	1-3
1.4 Mechanical Dimension.....	1-4
Chapter 2 System Installation	2-1
2.1 Embedded Board H/W Jumper Setting Introduction.....	2-1
2.1.1 Main Board	2-1
2.1.2 Extension Board	2-7
2.2 Selectable I/O Kit Installation.....	2-9
2.3 Memory Installation	2-9
2.4 HDD Installation.....	2-10
2.5 Half-size mini PCIe module Installation	2-11
2.6 CF and SD card Installation	2-12
2.7 Getting Started	2-12
2.8 I/O Interfaces	2-13
2.8.1 Front View	2-13
2.8.2 Rear View	2-14
2.8.3 Top View.....	2-15
2.8.4 Side View	2-15
2.9 Mounting Method	2-16
2.9.1 Panel Mount	2-16
2.9.2 VESA® Mount	2-17
Chapter 3 Driver Installation and Touch Usage Guide	3-1
3.1 Driver Installation.....	3-1
3.2 Calibration of the Touch Screen.....	3-1
3.3 Light Sensor Function Setting	3-3
Chapter 4 BIOS Setup Information	4-1
4.1 Entering Setup – Launch System Setup.....	4-1
4.2 Main.....	4-2
4.3 Configuration	4-3
4.4 Security	4-20
4.5 Boot.....	4-21
4.6 Save and Exit	4-23
Chapter 5 Important Instructions	5-1
5.1 Note on the Warranty	5-1
5.2 Exclusion of Accident Liability Obligation	5-1
5.3 Liability Limitations / Exemption from the Warranty Obligation.....	5-1
5.4 Declaration of Conformity.....	5-1
Chapter 6 Frequent Asked Questions	6-1

How to Use This Manual

The manual describes how to configure your FUDA2-S1x11 Series Panel PC system to meet various operating requirements. It is divided into four chapters, with each chapter addressing a basic concept and operation of Fan-less Panel PC System.

Chapter 1: System Overview. Present what you have in the box and give you an overview of the product specifications and basic architecture for Panel PC system.

Chapter 2: System Installation. Show the definitions and locations of all the interfaces and describe a proper installation guide so that you can easily configure your system.

Chapter 3: Driver Installation and Touch Usage Guide. Describe the operation guide for included driver and software.

Chapter 4: BIOS Setup Information. Specify the meaning of each setup parameters, how to get advanced BIOS performance and update new BIOS. In addition, POST checkpoint list will give users some guidelines of trouble-shooting.

Chapter 5: Important Instructions. Indicate some instructions which must be carefully followed when the Panel PC system is used.

Chapter 6: Frequent Asked Questions. Provide the answers for the most frequently asked questions.

The content of this manual is subject to change without prior notice. These changes will be incorporated in new editions of the document. The vendor may make supplement or change in the products described in this document at any time.

Revision History

Revision	Date	Details of Change(s)
V1.0	2015/6/17	Initial Release
V1.1	2015/7/1	Add chapter of "Embedded Board H/W Jumper Setting Introduction"
V1.2	2015/7/27	Add extension board information
V1.3	2016/9/22	Update FUDA2-S1711 contrast ratio and system, I/O information Correct cut-out dimension typo Add BIOS update SOP in FAQ
V1.4	2018/7/16	Add Windows 10 light sensor enable/disable SOP in FAQ

Chapter 1

System Overview

1.1 Introduction

FUDA2-S1x11 Series Panel PC is the next generation of Portwell's standard Panel PC product line. Keeping the successful experience in designing as well as marketing its ascendant, FUDA-S1x10 Series Panel PC, in mind, FUDA2-S1x11 Series Panel PC aims at serving IPC customers with much more powerful HMI solutions which provide high performance and low power consumption. Therefore, FUDA2-S1x11 Series Panel PC adopts the latest Intel Atom platform, Bay Trail-I SoC processor E3845 (10 W Max TDP, 2M Cache, 1.91 GHz).

The 4th generation Intel Atom Bay Trail-I series provides extended temperature from -40 to 110 degrees, high I/O connectivity, integrated memory controller, error correcting code (ECC), virtualization, and built-in security capabilities within 10W thermal design power (TDP). Among them, E3845 SoC processor is designed for applications including highly efficient and dedicated image signal processing with secure content delivery, visually appealing HMI thin clients and mobile HMI devices.

Equipped with a 5-wire resistive type touch screen and a panel with at least resolution of 1024 x 768 pixels, it is housed in an Aluminum bezel with anodizing coating that has a full IP65 rated front panel. This feature allows FUDA2-S1x11 Series Panel PC to be used extensively in harsh environments such as the operating temperature from -20 to 70 °C degrees. The panel PC includes all required interfaces for industrial application: 1 x DVI-I port, 2 x Gigabit Ethernet port, 3 x USB 1.1/2.0, 1 x USB 3.0, 2 x RS-232/422/485 port, 1 x 2.5" SATA HDD, 1x CF and 1 x SD socket for storage capacity. One SMA Antenna holes provide optional wireless solution via half size Mini-PCIe module.

Furthermore, facilitated with an ambient light sensor, FUDA2-S1x11 Series Panel PC is capable of automatically adjust panel brightness by sensing light intensity in the surroundings, which allows the Panel PC to optimize the display's visibility in semi-outdoor environments. Other than providing comfortable viewing experience, this function also benefits FUDA2 Series by lowering the power consumption and extending the lifetime of LED display.

To fulfill different application needs and to secure the system from power input change, the system accepts DC 12~24V wide range power input with 3-pin terminal block connector for various operating environment. The FUDA2-S1x11 Series Panel PC offers panel mounting and equipped with standard 75 x75, 100 x 100 mm VESA mounting holes. It supports many mainstream operating systems, such as Windows 8.1, Windows 7 and Linux.

1.2 Check List

The FUDA2-S1x11 Series Panel PC package covers the following items:

Essential

- ✓ One FUDA2-S1x11 Panel PC



Panel Size	Model Name
10.4"	FUDA2-S1011
12.1"	FUDA2-S1211
15"	FUDA2-S1511
17"	FUDA2-S1711
19"	FUDA2-S1911

- ✓ Panel Mount Kits



Panel Size	Kits (pcs)
10.4"	8 pieces
12.1"	12 pieces
15"	16 pieces
17"	16 pieces
19"	20 pieces

- ✓ Screws for HDD installation



M3X4L Screw 4 pieces

- ✓ Driver CD



- ✓ 3-pin Terminal Block Connector (Female)



Optional

- ✓ 60W Power Adapter with Power Cord (EU/US type) and Switch Cable



60W Power Adapter



Power Cord (US type)



Power Cord (EU type)



Power Switch Cable (from DC Jack to 3-pin TBC)

✓ Selectable I/O Kit

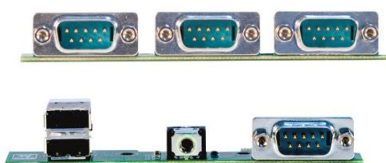

2x RS-232/422/485, 1x RS-232
(Expansion: Option 1)

1x RS-232/422/485, 2x USB ports and 1x Line-out
(Expansion: Option 2)

If any of these items is damaged or missing, please contact your vendor and keep all packing materials for future replacement and maintenance.

1.3 Product Specification

Model Name	FUDA2-S1011	FUDA2-S1211	FUDA2-S1511	FUDA2-S1711	FUDA2-S1911
Display					
LCD Size	10.4"	12.1"	15"	17"	19"
Resolution	XGA 1024 x 768	XGA 1024 x 768	XGA 1024 x 768	SXGA 1280 x 1024	SXGA 1280 x 1024
Brightness	450 cd/m ²	500 cd/m ²	450 cd/m ²	350 cd/m ²	350 cd/m ²
Contrast Ratio	3000:1	700:1	700:1	1000:1	1000:1
Backlight	LED type	LED type	LED type	LED type	LED type
Touch Window	5-Wire Resistive Single Touch (P-CAP Touch by project)				
System					
SOC	Intel® Atom™ Quad-Core E3845 (1.91 GHz)				
Memory	DDR3L SO-DIMM 1333/1600 MHz max up to 8 GB				
BIOS	AMI				
Graphics	Intel® Gen7 Graphics				
LVDS	Single/Dual Channel 24-bit				
LAN Chipset	Dual Intel® I210IT Gigabit Ethernet (Support Jumbo Frame)				
Audio	Realtek® High Definition Audio Codec				
Watchdog Timer	Programmable 1~255 secs				
Storage Device	2.5" SATA HDD / SSD, Compact Flash II up to 64 GB, SD card				
OS	Windows 7 / Windows 8.1 / Windows 10 / Linux™				
I/O Interface					
Series Port	2 x RS-232/422/485 (Expansion : default)				
Display	1 x DVI-I				
USB	1 x USB 2.0, 1 x USB 3.0, 2 x USB 2.0 (Expansion: default)				
Ethernet	2 x Gigabit Ethernet				
Others	1 x SMA Antenna hole for WiFi/3G Solution				
Expansion	1 x Half-size Mini PCIe socket 2 x RS-232/422/485, 1 x RS-232 (Expansion: option 1) 1 x Line-out, 1 x RS-232/422/485, 2 x USB 2.0 (Expansion: option 2)				
Mechanical					
Mounting (mm)	VESA Mount 75 x 75 & 100 x 100 ; Panel Mount				
Weight (Kg)(N)	3.5 Kg	4.3 Kg	5.3 Kg	6.8 Kg	7.8 Kg
Weight (Kg)(G)	5.8 Kg	6.2 Kg	8.2 Kg	9.5 Kg	11.2 Kg
Dimension	314 x 253 x 50.2 mm	343 x 282 x 53.2 mm	425.4 x 330 x 55.6 mm	437 x 375 x 58.6 mm	480 x 400 x 58.6 mm
Power					
Power Supply	DC 12 ~ 24V input with 3-pin Terminal Block Connector				
Consumption (Max)	32W (12V); 35W (24V)	29W (12V); 30W (24V)	30W (12V); 31W (24V)	38W (12V); 38W (24V)	34W (12V); 34W (24V)
Consumption (Min)	10W (12V); 12W (24V)	10W (12V); 12W (24V)	10W (12V); 12W (24V)	10W (12V); 12W (24V)	10W (12V); 12W (24V)
Power Adaptor	12V, 5A/60W(Optional)				
Environmental					
OP /Storage Temp	-25~70 °C / -40~85 °C (20~90% non-condensing)				
Vibration	1.0G (CF/SSD/SD) and 0.5G (HDD) , Power on & 2.16G, Packaged; 5~500Hz				
Shock	15G peak acceleration, 11 ms (Power on condition)				
Drop	Package with Carton from 96.5 cm (1-Corner, 3-Axis, 6-Face)				
Front Panel Protection	IP65 (Front) / IP20 (Rear) (IEC 60529 Edition 2.1 Standard)				
Certification	CE/FCC Class A				

1.4 Mechanical Dimension

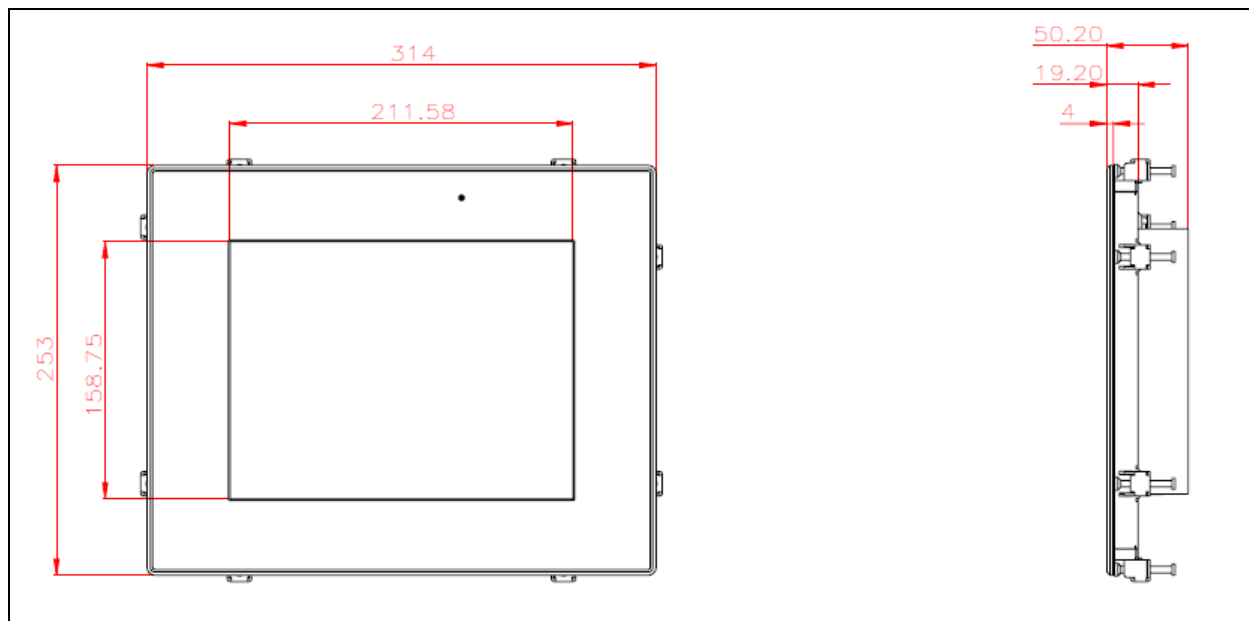

Front and side view of the FUDA2-S1011 system

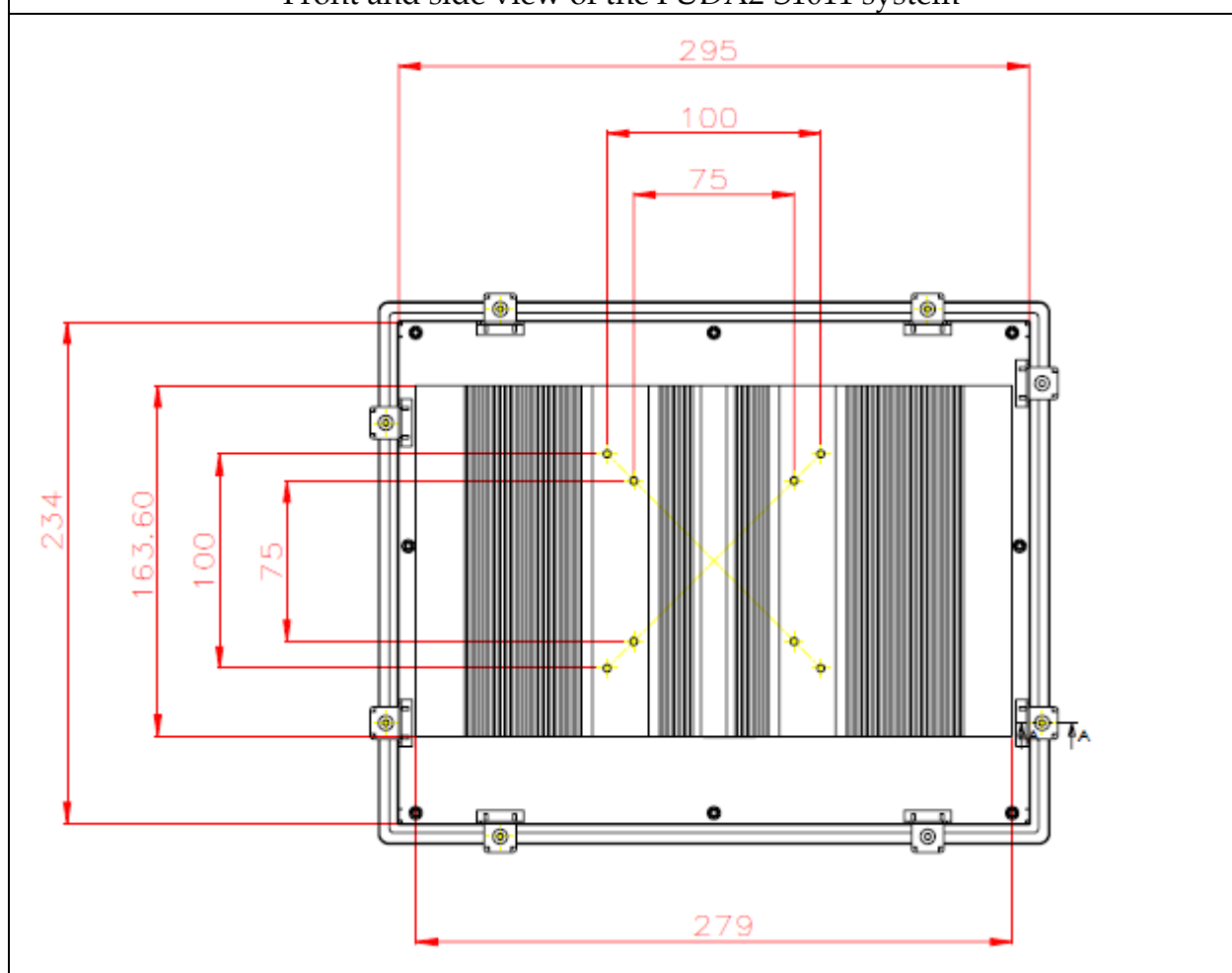

Back view of the FUDA2-S1011 system

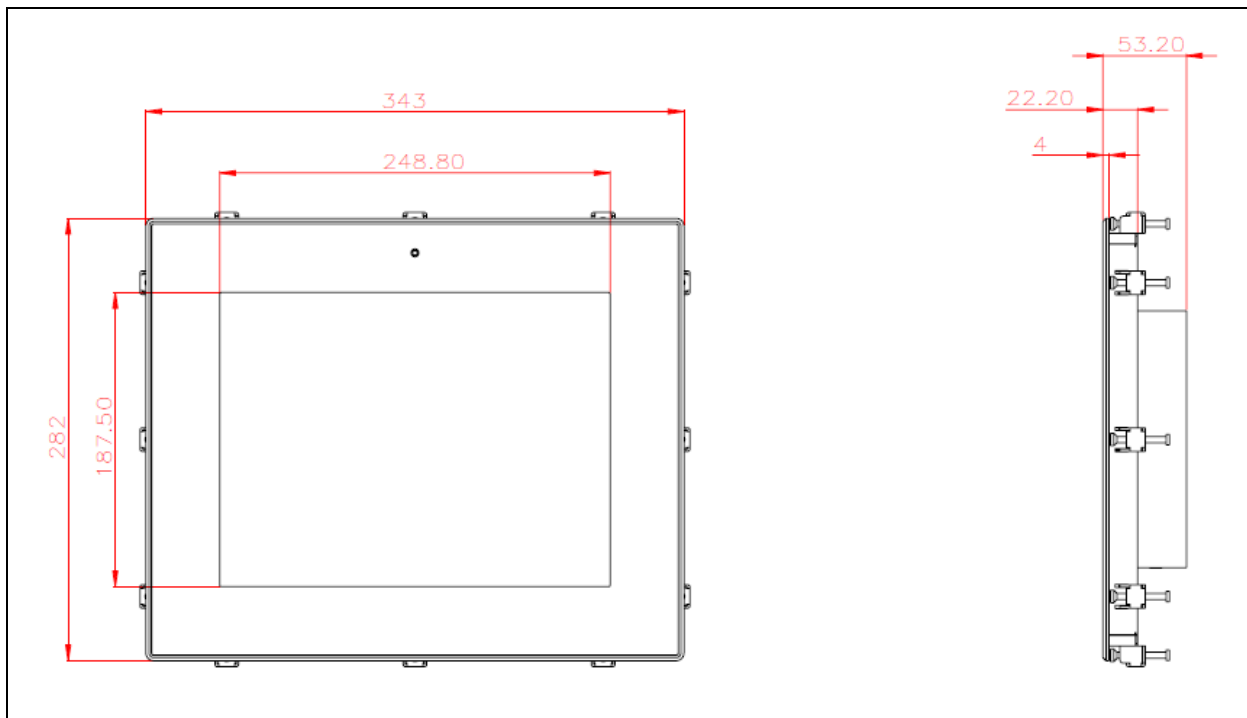

Front and side view of the FUDA2-S1211 system

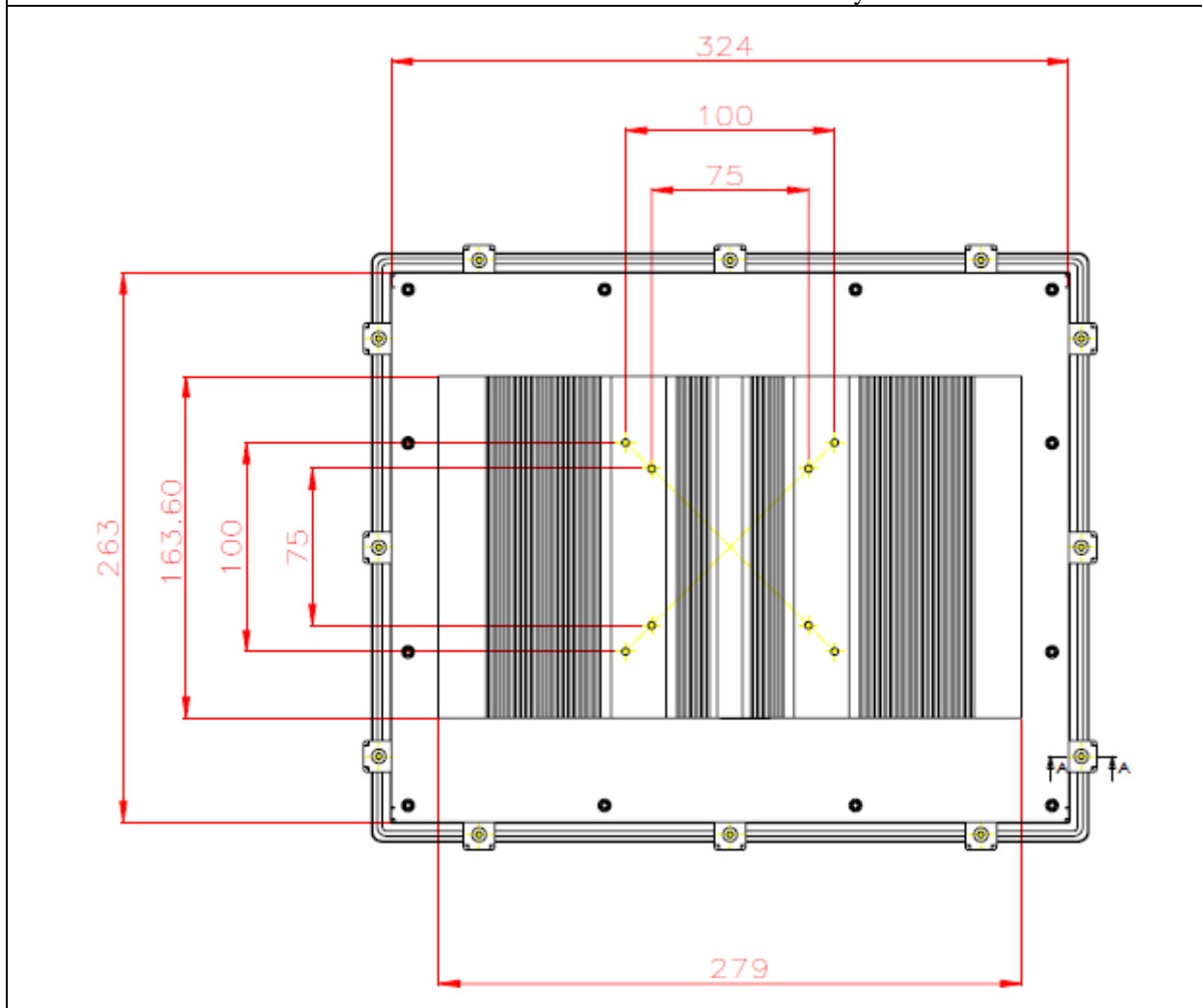

Back view of the FUDA2-S1211 system

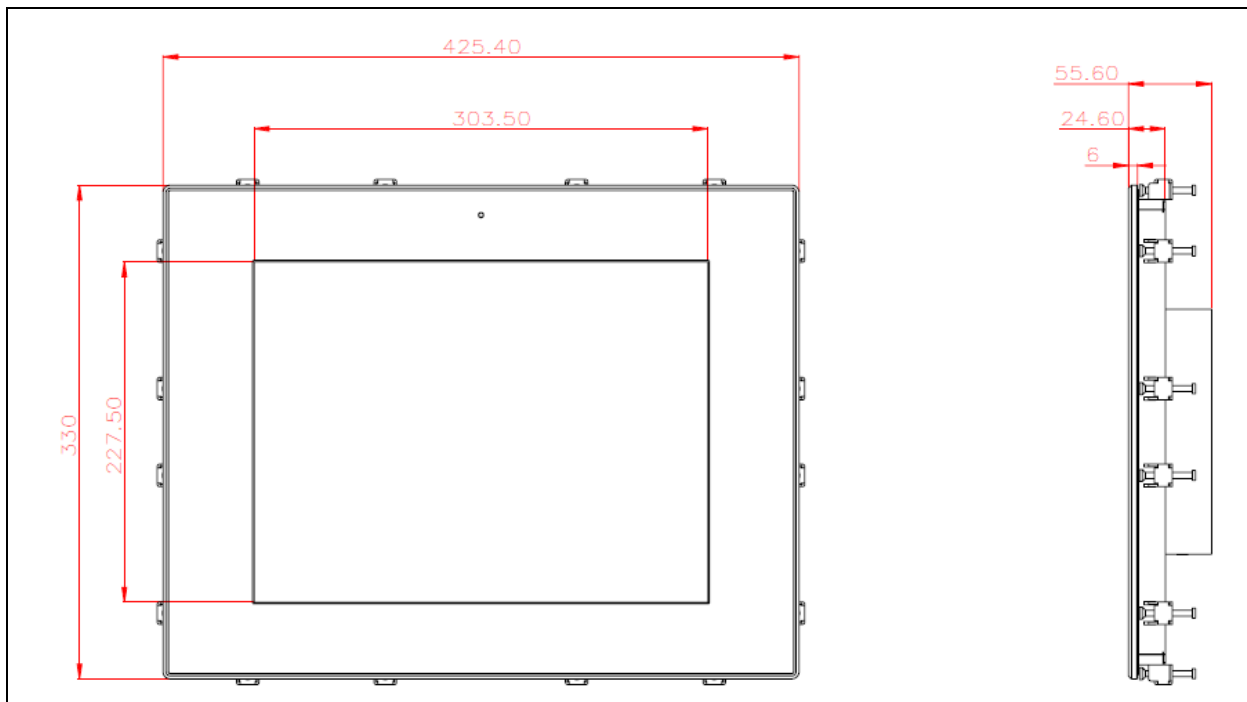

Front and side view of the FUDA2-S1511 system

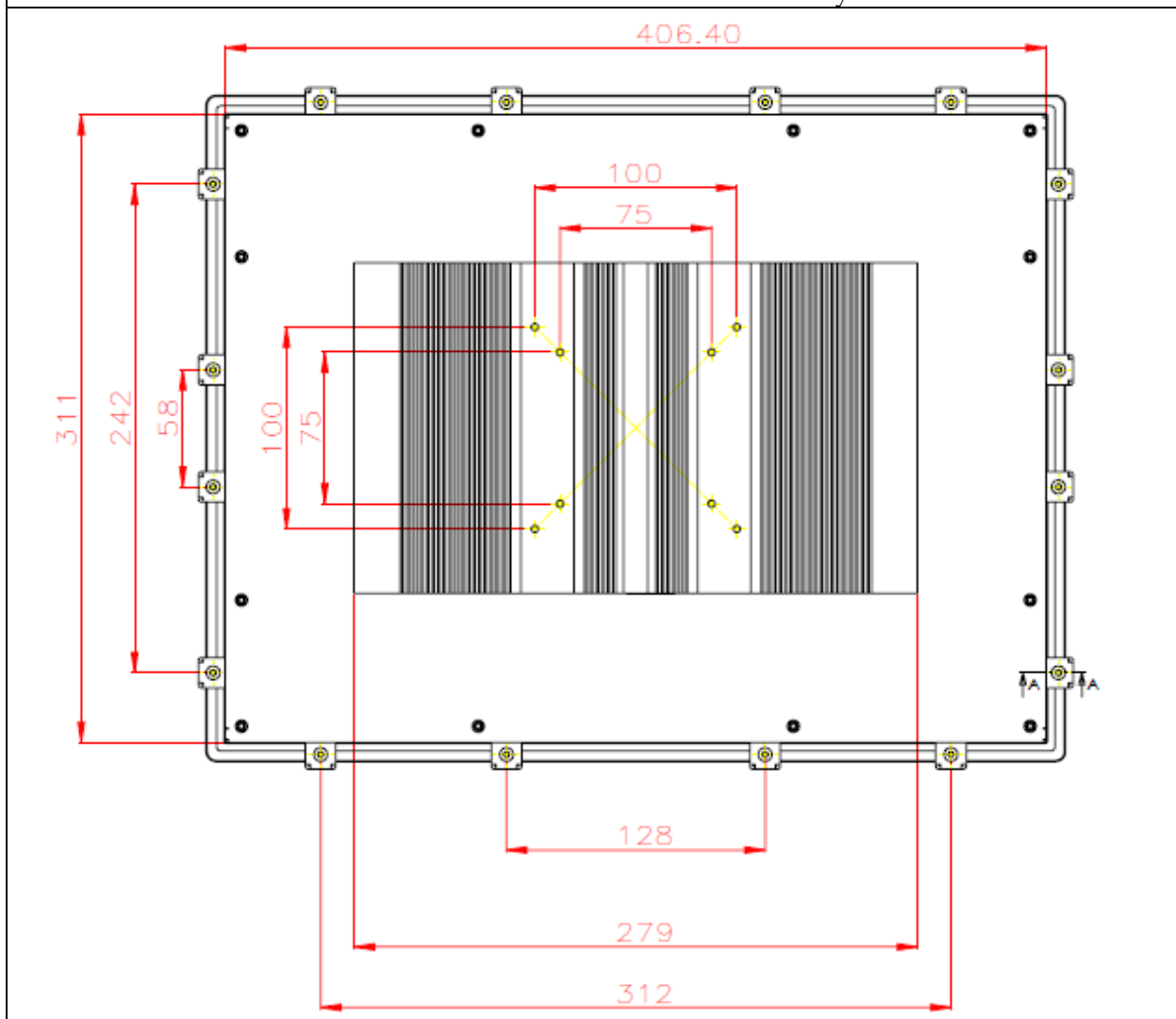

Back view of the FUDA2-S1511 system

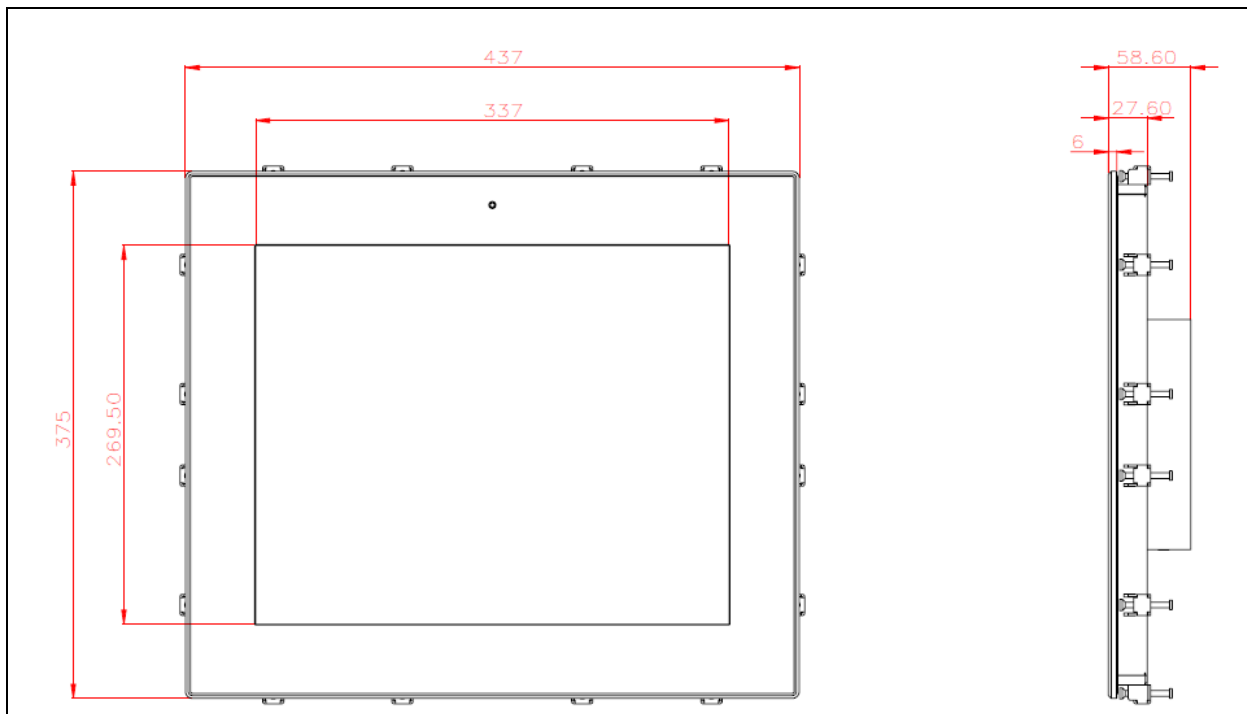

Front and side view of the FUDA2-S1711 system

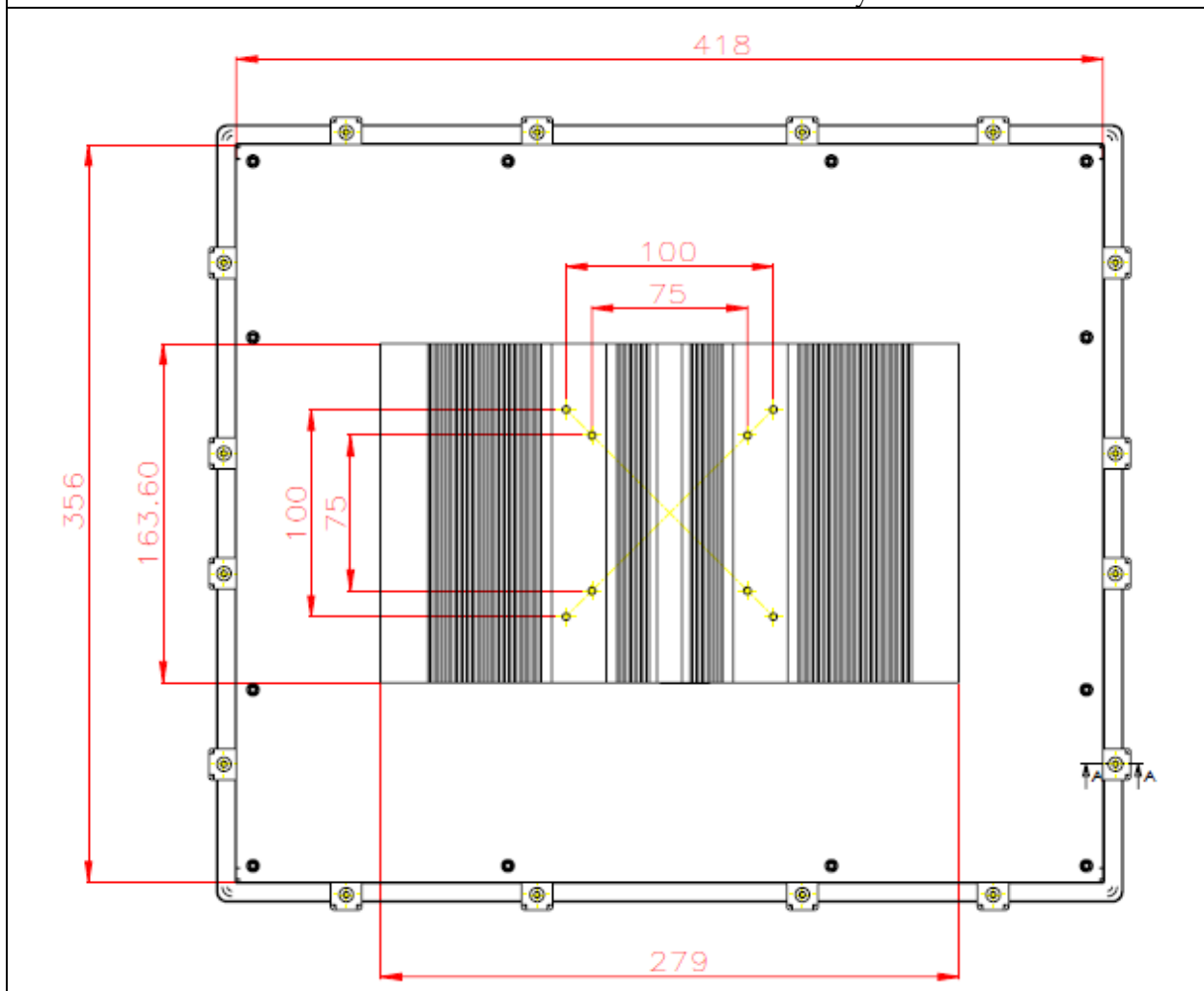

Back view of the FUDA2-S1711 system

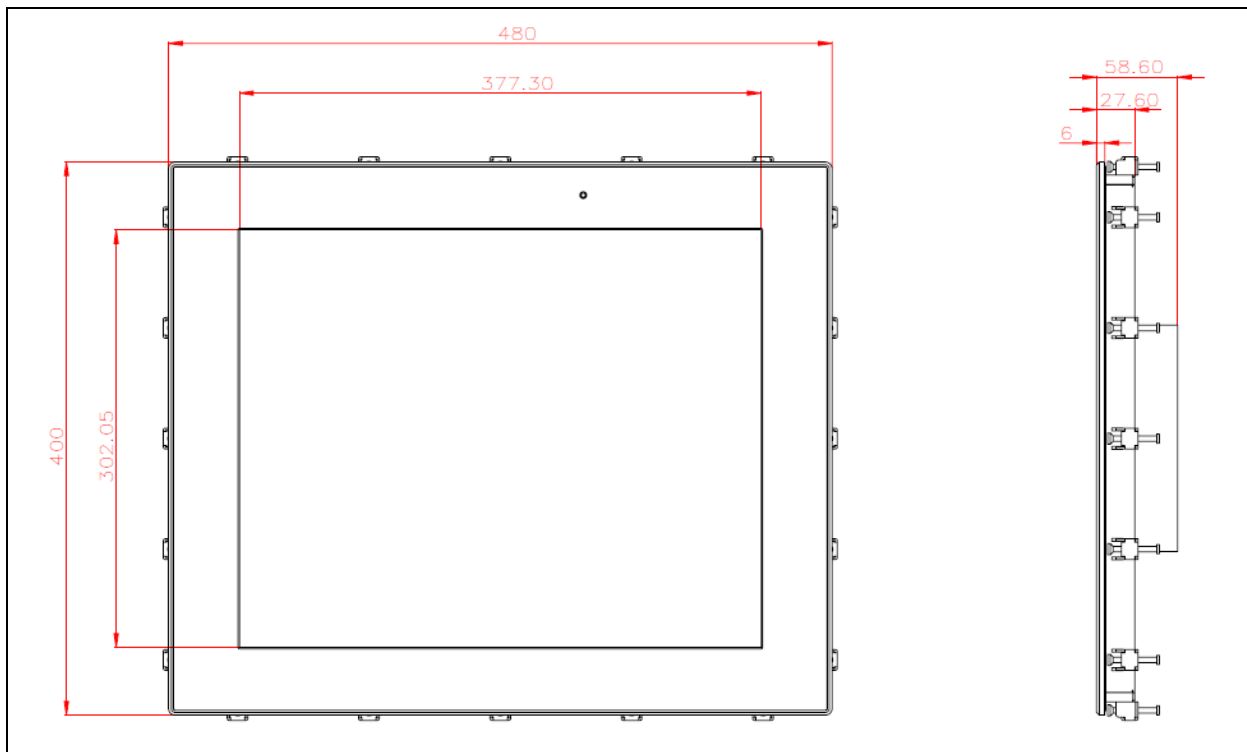

Front and side view of the FUDA2-S1911 system

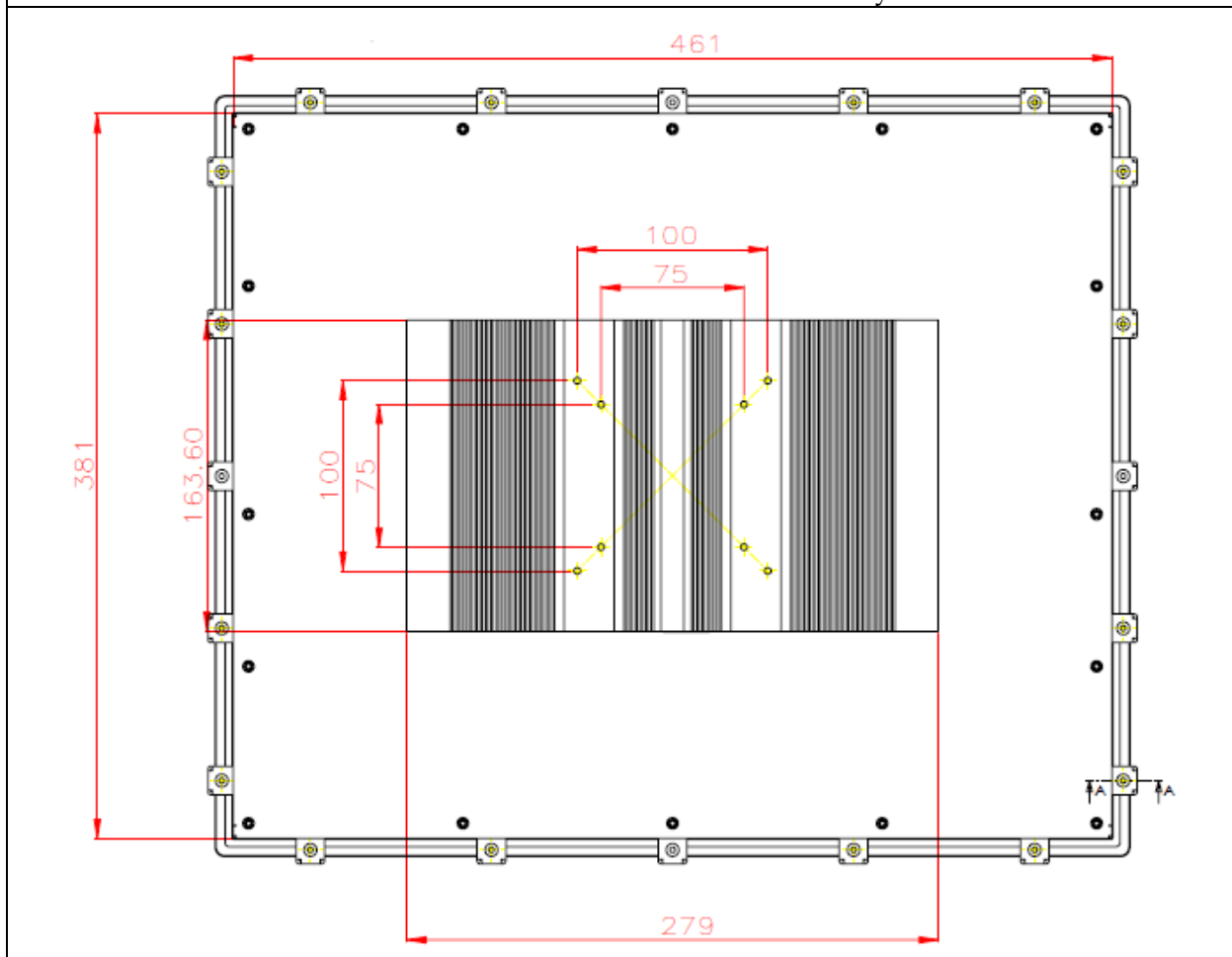

Back view of the FUDA2-S1911 system

Chapter 2 System Installation

This chapter provides you with instructions to set up your FUDA2-S1x11 Series Panel PC. Definitions and locations of all the interfaces are described so that you can easily configure your system.

2.1 Embedded Board H/W Jumper Setting Introduction

2.1.1 Main Board

FUDA2-S1x11 Series Panel PC adopts PEB-99A4 mother board. You may configure the Panel PC by setting jumpers of the mother board to match the needs of your applications. To select any option, cover the jumper cap (SHORT) or remove (NC) it from the jumper pins according to the following instructions.

*Note: NC stands for “Not Connect”.

Component side:

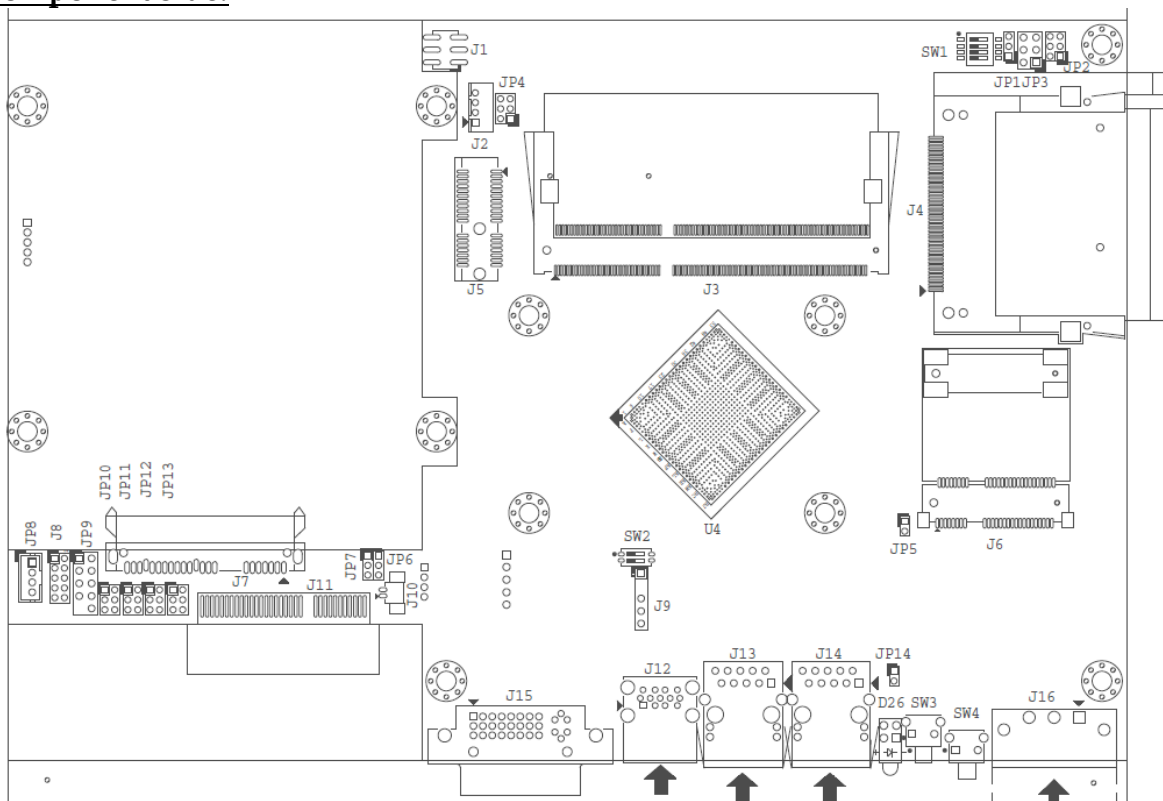

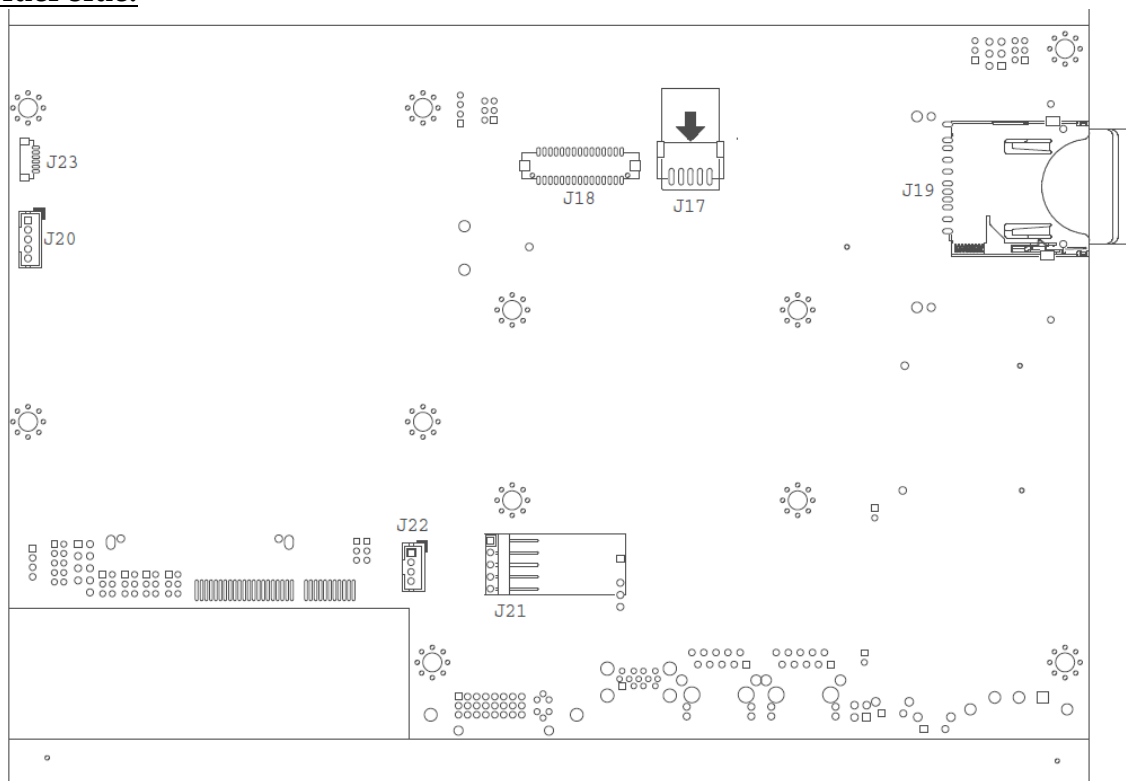
Solder side:**Connector and Jumper setting:**

Connector	
J2	Reserve for CH7511 Backlight control.(Wafer/2.0mm)
J3	DDR3 SO-DIMM Socket.
J4	Compact Flash connector.
J5	PCI-E X 1 Slot.
J6	Mini-PCI-E Slot.(Half size)
J7	SATA Connector with power.
J8	GPIO Connector.(2*5 Pin/2.0mm)
J9	SM- Bus Connector.
J10	Battery Connector.
J11	PCI-E X4 Slot(Right angle) for Audio and COM Port Signal .
J12	USB Port 0~1 D-Sub Connector. (Up:USB2.0 Down:USB3.0)
J13	RJ45 Connector.
J14	RJ45 Connector.
J15	DVI-I D-sub Connector.
J16	Power Input Connector. (Terminal Blocks 3Px1/5.08mm female)
J17	LCD Inverter Power Connector. (1*5 Pin wafer/2mm)
J18	LCD LVDS Connector. (2*15 Pin Hirose/1.25mm)
J19	SD Card.
J20	Front Panel Connector. (1*5 Pin Wafer/2mm)
J21	Touch Panel Connector. (1*5 Pin Header/2.54mm)
J22	USB Port 3 Connector (1*4 Pin Wafer/2mm).
J23	Light sensor Connector (1*6 Pin Wafer/1mm).

Jumpers	
JP1	Clear CMOS.
JP2	Backlight voltage setup.
JP3	LCD Panel Voltage Setup.
JP4	LCD Panel Type Setup.
JP7	GPIO Voltage selection.
JP8	Audio out.(From amplifier)
JP9	LPC Debug Port.
JP10	COM2 PORT RI and power source adjust pin.
JP11	COM1 PORT RI and power source adjust pin.
JP12	COM4 PORT RI and power source adjust pin.
JP13	COM3 PORT RI and power source adjust pin.
SW1	LCD Resolution Setup
SW2	AT/ATX & BIOS recovery Setup.

J8: GPIO Connector (2*5 Pin Header/2mm):

PIN NO.	DESCRIPTION	PIN NO.	DESCRIPTION
1	GPIO0	2	GPIO4
3	GPIO1	4	GPIO5
5	GPIO2	6	GPIO6
7	GPIO3	8	GPIO7
9	GND	10	+5V

J16: Power Input Connector (Terminal Blocks 3Px1/5.08mm female)

PIN NO.	DESCRIPTION
1	GND EARTH
2	Vin-
3	Vin+

J17: LCD Inverter Power Connector (1*5 Pin wafer/2mm)

PIN NO.	DESCRIPTION
1	LCD_ENBLT
2	GND
3	+12V
4	LCD_BLADJ
5	+5V

J18: LCD LVDS Connector (2*15 Pin Hirose/1.25mm)

PIN NO.	Description	PIN NO.	Description
1	YAP0	2	YAM0
3	YAP1	4	YAM1
5	YAP2	6	YAM2
7	YAP3	8	YAM3
9	CLKAP	10	CLKAM
11	YBP0	12	YBM0

13	YBP1	14	YBM1
15	YBP2	16	YBM2
17	YBP3	18	YBM3
19	CLKBP	20	CLKBM
21	DDCPCLK	22	DDCPDATA
23	GND	24	NC
25	GND	26	GND
27	+LVDS	28	+LVDS
29	NC	30	+LVDS

J20: Front Panel Connector (1*5 Pin Wafer/2mm)

PIN NO.	DESCRIPTION
1	LED (Hi: Green LED +; Low: Orange LED -)
2	LED (Hi: Orange LED+; Low: Green LED-)
3	Power Button
4	Power Button
5	NC

J21: Touch Panel Connector (1*6 Pin Header/2.54mm)

PIN NO.	DESCRIPTION
1	UL
2	UR
3	Probe
4	LL
5	LR

J22: USB Port 3 Connector (1*5 Pin Wafer/2mm)

PIN NO.	DESCRIPTION
1	+ 5V
2	USB_D3-
3	USB_D3+
4	GND

JP1: CMOS Setup

PIN NO.	DESCRIPTION
1-2	Normal (Keep CMOS Setup) ★ Default
2-3	Clear CMOS Setup

JP2: LCD Panel Inverter ON/OFF Signal Setup

PIN NO.		DESCRIPTION
1-3	2-4	+5V High Active ★ Default
Short	Short	
PIN NO.		DESCRIPTION
1-3	4-6	+12V High Active
Short	Short	

PIN NO.		DESCRIPTION
2-4	3-5	
Short	Short	+5V Low Active
PIN NO.		DESCRIPTION
3-5	4-6	
Short	Short	+12V Low Active

JP3: LCD Panel Voltage Setup

PIN NO.			DESCRIPTION
1-3	3-5	3-4	Voltage
Short			+3.3V TFT LCD ★ Default
	Short		+5V TFT LCD
			+12V TFT LCD

JP4: LCD Panel Type Setup

PIN NO.				DESCRIPTION
1-3	3-5	2-4	4-6	
Short				CCFL LCD
	Short			LED LCD ★ Default
		Short		CCFL LCD Brightness Limit
			Short	LED LCD Brightness Limit

JP7: GPIO Power Selection

PIN NO.	DESCRIPTION
1-2	5V Level ★ Default
2-3	3.3V Level

JP8: Internal Audio Connector

PIN NO.	DESCRIPTION
1	Audio_R+
2	Audio_R-
3	Audio_L+
4	Audio_L-

JP9: LPC Debug Port Pin Assignment

PIN NO.	DESCRIPTION	PIN NO.	DESCRIPTION
1	LAD0	2	3.3V
3	LAD1	4	LPC_RESET
5	LAD2	6	LPC_FRAME
7	LAD3	8	LPC_CLCOK
		10	GND

JP10: COM2 Pin 9 Function Setup

PIN NO.			DESCRIPTION
1-2	3-4	5-6	
Short			+5V Output
	Short		RI Function ★ Default
		Short	+12V Output

JP11: COM1 Pin 9 Function Setup

PIN NO.			DESCRIPTION
1-2	3-4	5-6	
Short			+5V Output
	Short		RI Function ★ Default
		Short	+12V Output

JP12: COM4 Pin 9 Function Setup

PIN NO.			DESCRIPTION
1-2	3-4	5-6	
Short			+5V Output
	Short		RI Function ★ Default
		Short	+12V Output

JP13: COM3 Pin 9 Function Setup

PIN NO.			DESCRIPTION
1-2	3-4	5-6	
Short			+5V Output
	Short		RI Function ★ Default
		Short	+12V Output

SW1: LCD Resolution Setup

PIN NO.				Resolution	Port
1	2	3	4		
ON	ON	ON	ON	800 x 600 (18bit)	Single
OFF	ON	ON	ON	1024 x 768 (18bit)	Single
ON	OFF	ON	ON	1024 x 768 (24bit)	Single
OFF	OFF	ON	ON	1280 x 768 (18bit)	Single
ON	ON	OFF	ON	1280 x 800 (18bit)	Single
OFF	ON	OFF	ON	1280 x 960 (18bit)	Single
ON	OFF	OFF	ON	1280 x 1024 (24bit)	Dual
OFF	OFF	OFF	ON	1366 x 768 (18bit)	Single
ON	ON	ON	OFF	1366 x 768 (24bit)	Single
OFF	ON	ON	OFF	1440 x 900 (24bit)	Dual
ON	OFF	ON	OFF	1400 x 1050 (24bit)	Dual
OFF	OFF	ON	OFF	1600 x 900 (24bit)	Dual

ON	ON	OFF	OFF	1680 x 1050 (24bit)	Dual
OFF	ON	OFF	OFF	1600 x 1200 (24bit)	Dual
ON	OFF	OFF	OFF	1920 x 1080 (24bit)	Dual
OFF	OFF	OFF	OFF	1920 x 1200 (24bit)	Dual

*Note: Default setting depends on the panel size.

*Note: Diagram of adjusting to resolution 800 x 600

PIN NO.				Resolution	Port
1	2	3	4	800 x 600 (18bit)	Single
ON	ON	ON	ON		

SW2: AT/ATX & BIOS recovery Setup

PIN NO.	DESCRIPTION
1-4(Port1)	ON: AT Mode OFF:ATX Mode ★ Default
2-3(Port2)	ON: Recover BIOS OFF: Disable ★ Default

*Note: Diagram of SW2 default setting

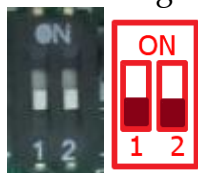

2.1.2 Extension Board

FUDA2-S1x11 Series Panel PC can adopt different I/O extension board. You may configure the Panel PC by different I/O kit options to match market needs.

Default (PA-P1S2U2):

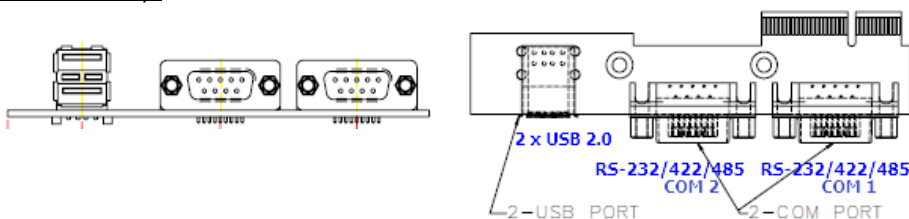

Option 1 (PA-P1S3):

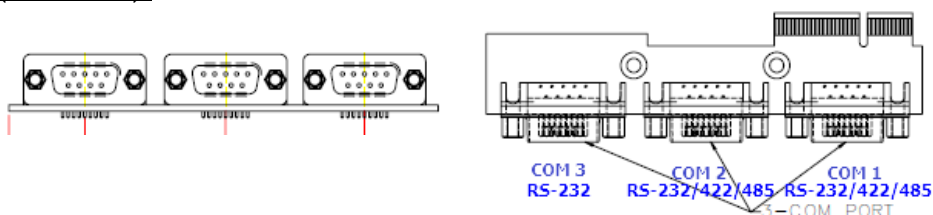

Option 2 (PA-P1S1U2A1):

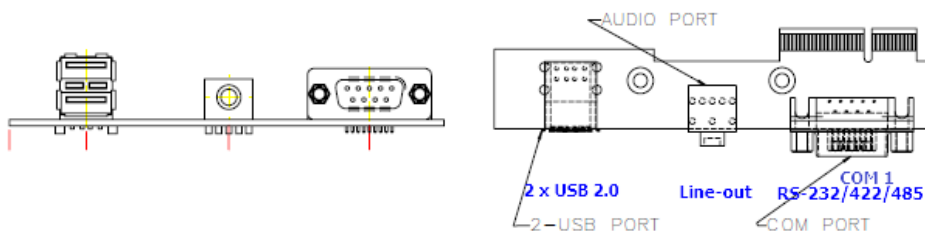

COM port RS-232/422/485 mode setup:

Note: Both COM1 & COM2 support RS-232/422/485 (selectable in BIOS menu).

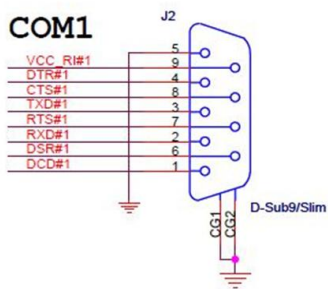

RS-232 Mode Setup

PIN No.	Signal Description	PIN No.	Signal Description
1	Data Carrier Detect (DCD)	2	Receive Data (RXD)
3	Transmit Data (TXD)	4	Data Terminal Ready (DTR)
5	GND	6	Data Set Ready (DSR)
7	Request to Send (RTS)	8	Clear to Send (CTS)
9	Ring Indicator (RI)		

RS-422 Mode Setup

PIN No.	Signal Description	PIN No.	Signal Description
1	TX-	2	TX+
3	Rx+	4	Rx-
5	GND	6	RTS-
7	RTS+	8	CTS+
9	CTS-		





RS-485 Mode Setup

PIN No.	Signal Description	PIN No.	Signal Description
1	DATA-	2	DATA+
3	NC	4	NC
5	GND	6	NC
7	NC	8	NC
9	NC		

2.2 Selectable I/O Kit Installation

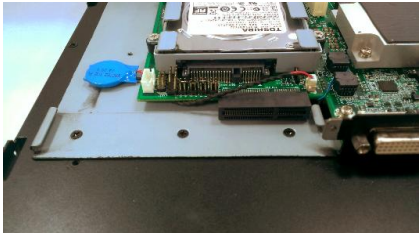

In addition to default I/O interfaces, including 1x DVI, 2x RS-232/422/485, 4x USB and 2x Gigabit Ethernet, to further enhance system flexibility as well as to increase the versatility in application fields, FUDA2 Series allows users to select different I/O combinations for various market demands.





1. Confirm the position of Golden Finger Connector	2. Fix the I/O extension board to the main board system
	
	

2.3 Memory Installation





FUDA2 Series supports one DDR3L SO-DIMM memory module. It's easy to install by just opening the back cover.

1. Unscrew the back cover to detach it	2. Remove the IPC back cover
	

3. Insert Memory module to the slot	4. Press down the memory module and finish installation
	

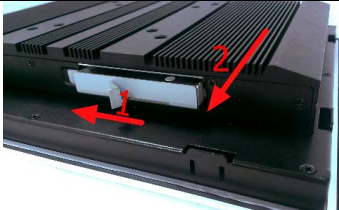

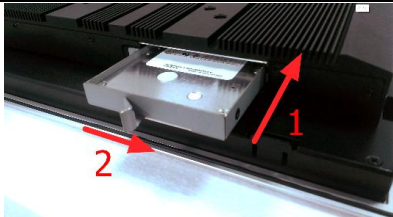



2.4 HDD Installation

FUDA2 Series supports 1x 2.5" HDD/SSD. The unique design of the HDD tray allows easy installation and maintenance. (The height must be less than 10mm)

1. Remove the screws of HDD tray cover	2. Push the rod to release HDD tray
	
3. Install the HDD into tray with screws	4. Push HDD tray back into PPC
	
5. Screw the cover and finish installation	6. Inside view of installed HDD in PPC
	

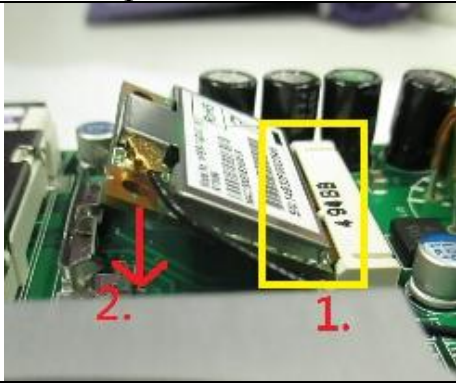

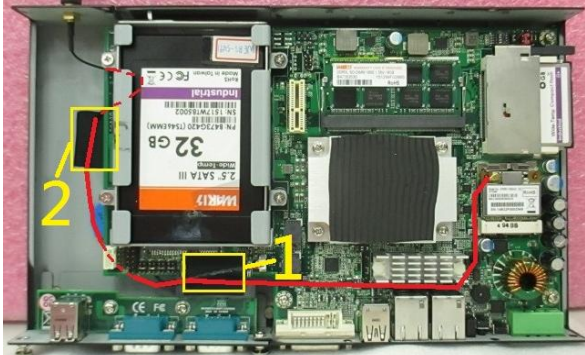
2.5 Half-size mini PCIe module Installation

FUDA2 Series supports 1x half-size mini PCIe module expansion. Half-size WIFI module is used as an example to demonstrate installation process below.

<p>1. Unscrew the back cover to detach it</p>	<p>2. Remove the IPC back cover</p>
	
<p>3. Connect SMA cable to module</p>	<p>4. Insert the card to mini PCIe socket onboard and press down to fix it</p>
	
<p>5. Screw the SMA cable to ANT hole at top I/O cover</p>	<p>6. Arrange the SMA cable inside</p>
	
<p>7. Screw the cover and finish installation</p>	<p>8. Install the antenna and connect to router</p>
	



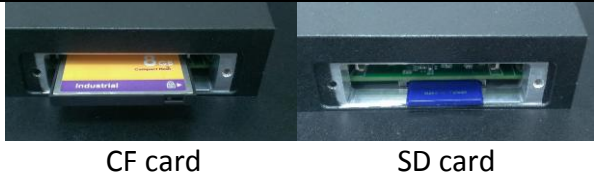

2.6 CF and SD card Installation

CF and SD card are both supported in FUDA2 Series. It is easy to install CF and SD card by opening the cover at side and insert the card.

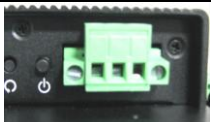

1. CF cover locates at the right side. Unscrew and remove the side bracket.	2. Carefully insert CF and SD card into the socket.
	 <p style="text-align: center;">CF card SD card</p>
3. Complete insertion (Eject CF card by pressing the elastic stick on the right side)	4. Screw the side bracket and finish installation
 <p style="text-align: center;">CF card SD card</p>	

2.7 Getting Started

FUDA2 Series support 12~24V DV input via 3-pin terminal block connector.

1. Male-type 3-pin terminal block connector located at rear I/O	2. Take the female type 3-pin terminal block connector in accessory kit
	
3. Fix female type 3-pin terminal block connector to the system by screw.	4. Follow pin definition and fix power cable to 3-pin thermal block connector by screw
	

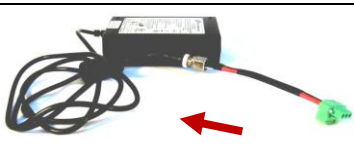
60W AC to DC power adapter and switch cable from adapter to 3-pin terminal block connector is an optional accessory.

1. Screw 3 pin terminal block cable to adaptor	2. Connect 3-pin terminal block connector to PPC through AC in with adaptor
	

2.8 I/O Interfaces

2.8.1 Front View

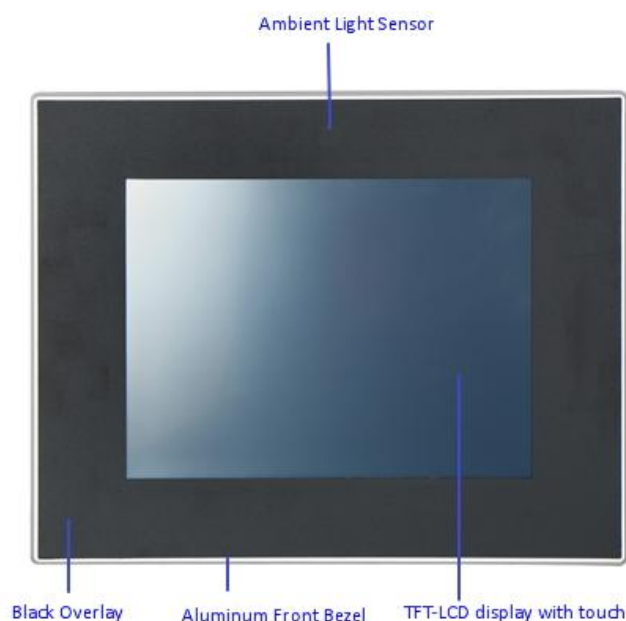

Ambient Light Sensor:

The ambient light sensor can detect light intensity in the surrounding. This feature allows the Panel PC to adjust panel brightness accordingly.

TFT-LCD Display with touch:

The Panel PC is built in a TFT-LCD display and designed with a 5-wire resistive touch screen. The touch screen allows contacts of pen or finger to move the mouse pointer but only functions normally after integrating necessary software.

*Note: Do not use a hard or a pointed object (like screw drivers or pliers) to operate the touch screen.

*Note: P-CAP touch screen could be by project.

Aluminum Front Bezel:

Rugged Aluminum front bezel meets IP65 protection.

Black Overlay:

Customized nameplate is an option in addition to standard black overlay.

2.8.2 Rear View

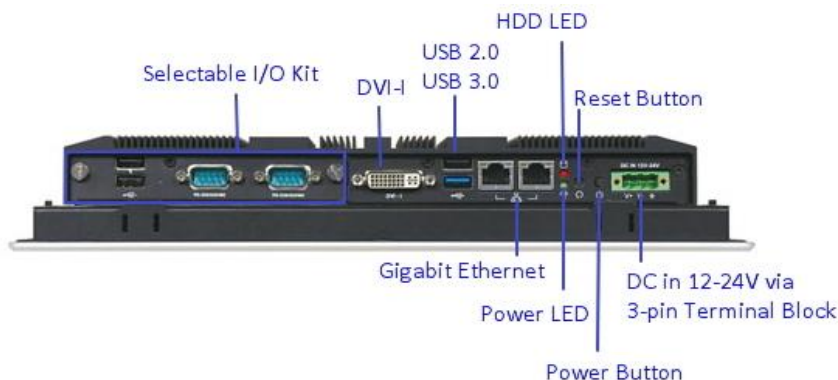

DC in 12-24V via 3-pin Terminal Block Connector:

Provide power connection of Panel PC to the main power source via DC power cable or AC/DC adapter.

Power Button:

Press the button to turn ON/OFF the Panel PC.

Reset Button:

Press the button to restart the Panel PC.

Power LED and HDD LED:

It demonstrates the power in and HDD working status of the Panel PC.

Status	Power LED	HDD LED
Off	N/A	N/A
Working	Green	Red

Gigabit Ethernet:

Two Gigabit Ethernet (10/100/1000 Mbits/sec) LAN ports by using dual Intel® I210IT GbE Ethernet Controller (Support Jumbo Frame)

USB (Universal Serial Bus) ports:

Connectors for USB-compatible devices

With different I/O kit combination...	Total # of USB ports	Details
Default	4	3x USB 2.0 & 1x USB 3.0
Option 1	2	1x USB 2.0 & 1x USB 3.0
Option 2	4	3x USB 2.0 & 1x USB 3.0

DVI-I:

An external monitor can be provided via DVI-I interface.

COM ports:

Connectors for RS-232/422/485 connection

*Note: The RS-232/422/485 configuration is determined by BIOS setting. Check BIOS setting for details.

With different I/O kit combination...	Total # of COM ports	Details
Default	2	2x RS-232/422/485
Option 1	3	2x RS-232/422/485 & 1x RS-232
Option 2	1	1x RS-232/422/485

Line-out:

Connectors for audio line-out

With different I/O kit combination...	Total # of Audio ports	Details
Default	0	N/A
Option 1	0	N/A
Option 2	1	1x Line-out

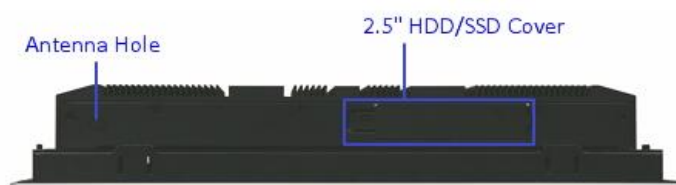
2.8.3 Top View**2.5" HDD/SSD Cover:**

Remove the cover and install the 2.5" HDD/SSD.

*Note: Refer to section 2.4 for installation guide.

Antenna Hole:

It is reserved for WiFi or 3G solution.

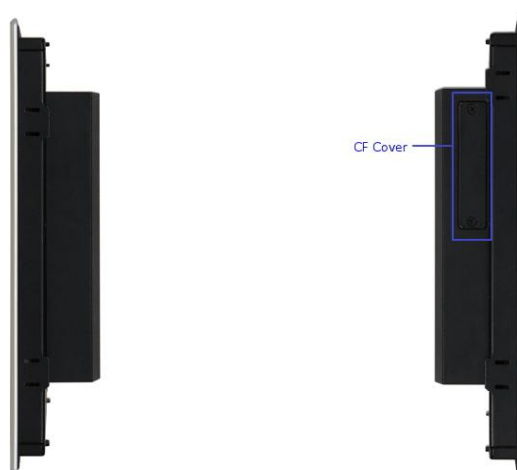
2.8.4 Side View**CF Cover:**

Remove the cover and install the CF card.

*Note: Refer to section 2.5 for installation guide.

2.9 Mounting Method

2.9.1 Panel Mount

The Panel PC can be mounted into a panel or a sub-frame for industrial cabinet via panel mount holes and kits. Check the installation guide and cut-out dimension below.

*Note: In order to ensure the Panel PC to be protected against dust and water, mount the system on a non-textured surface.



Installation Guide

1. Hook Clip

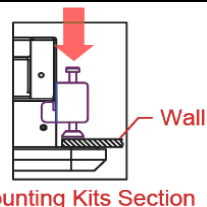
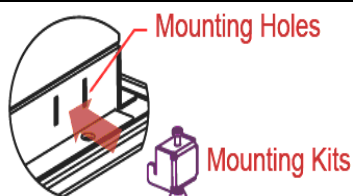

2. Screw the Clip tightly (Spec ≤ 1.35 N)

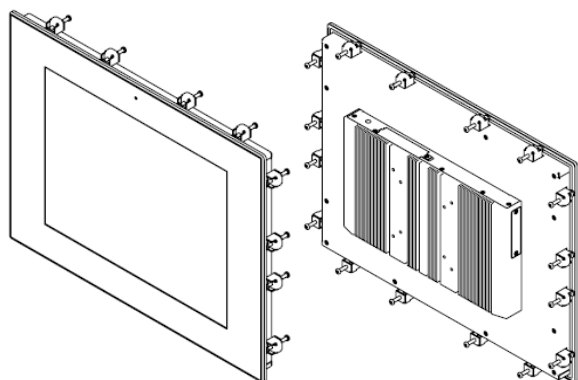

3. Hook the mounting clamps with screws (included) from the back side



Cut-out Dimension

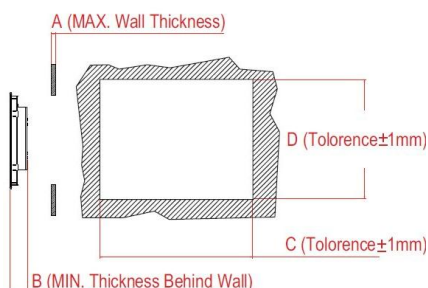

FUDA2-S1x11	A(mm)	B(mm)	C(mm)	D(mm)	Kits
10.4"	<10.7	50.2	297	236	X 8
12.1"	<10.9	53.2	326	265	X 12
15"	<11.3	55.6	409	313	X 16
17"	<12	58.6	420	358	X16
19"	<12	58.6	463	383	X20

2.9.2 VESA® Mount

The Panel PC can install with VESA® 75x75/100x100 compliant adapter plate.

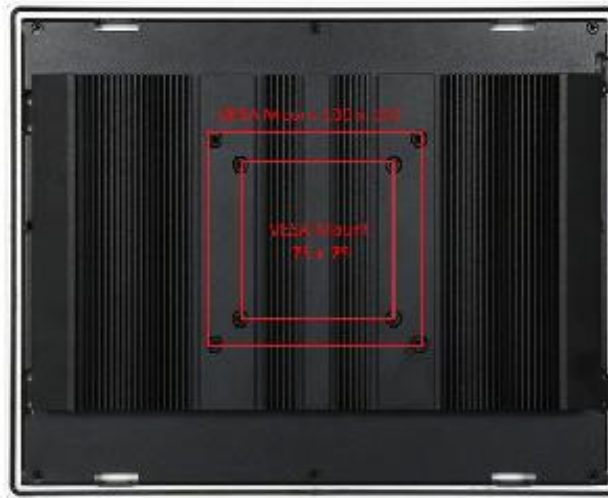

Chapter 3 Driver Installation and Touch Usage Guide

3.1 Driver Installation

All drivers are included in Panel PC Series V1.00 CD-title in the accessory box.

3.2 Calibration of the Touch Screen

Calibration aligns the active touch-sensitive area of the touch screen with the image on the display. Calibration also determines the edges of the screen’s image and locates the center of the touch screen. If the touch screen is not calibrated properly, the active area of the touch screen may not be aligned with the screen’s image or may be unnecessarily small in size.

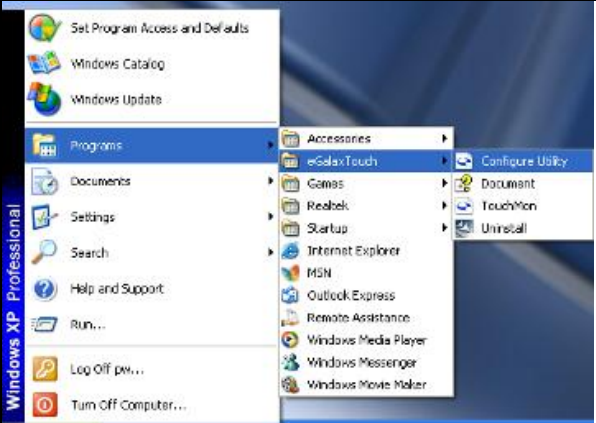
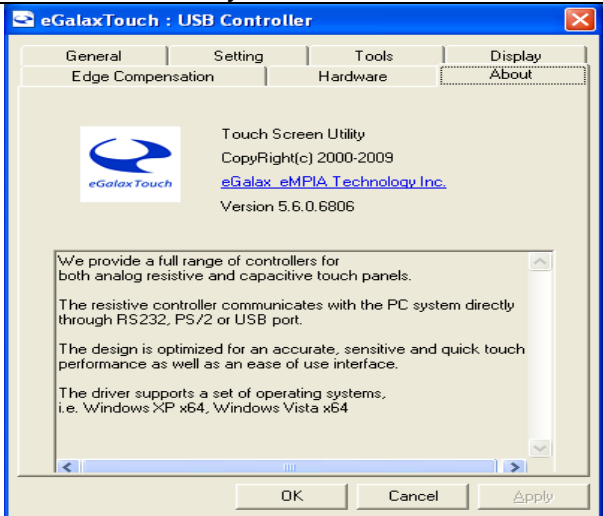
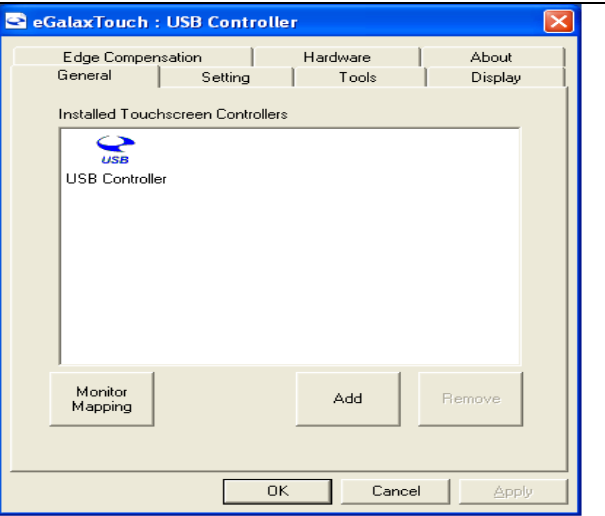
<p>1. Make sure the touch driver utility is installed properly</p>	<p>2. Click [Start] to find the “eGalaxTouch Configure Utility”</p>
	
<p>3. Click [About], you can see the information and version of the “Touch Screen Utility”</p>	<p>4. Click [General], the installed USB touch screen controller is shown.</p>
	

5. Click [Setting], you can choose the 9 points or 25 points linearization style.

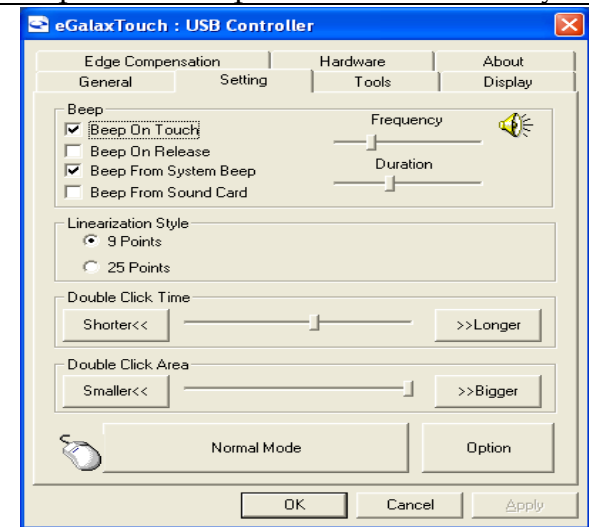

6. Click [Tools] to align touch with the display and verify touch accuracy.

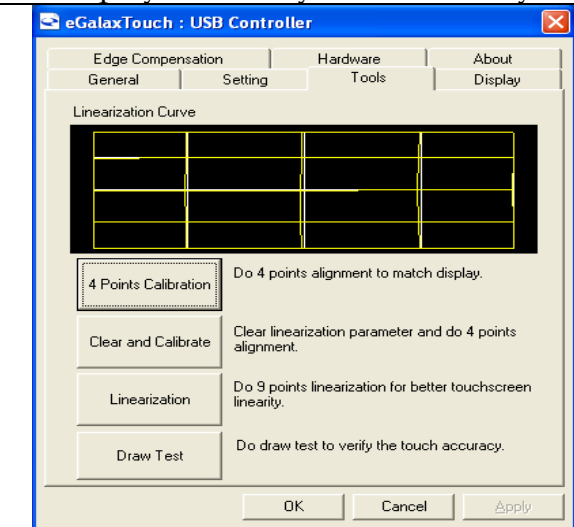

Click [4 Points Calibration] & [Linearization] to match display.

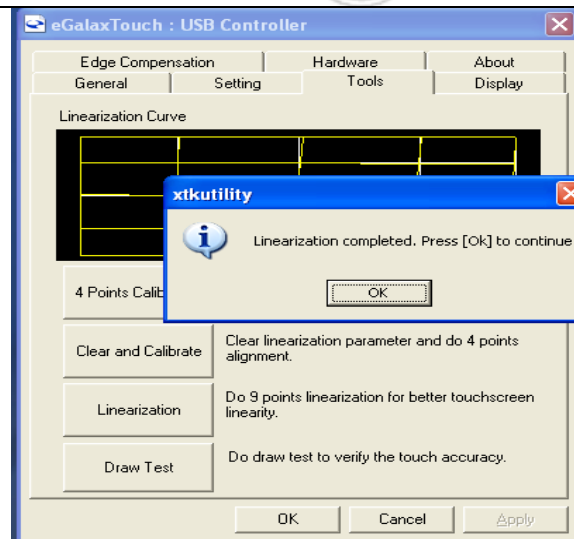
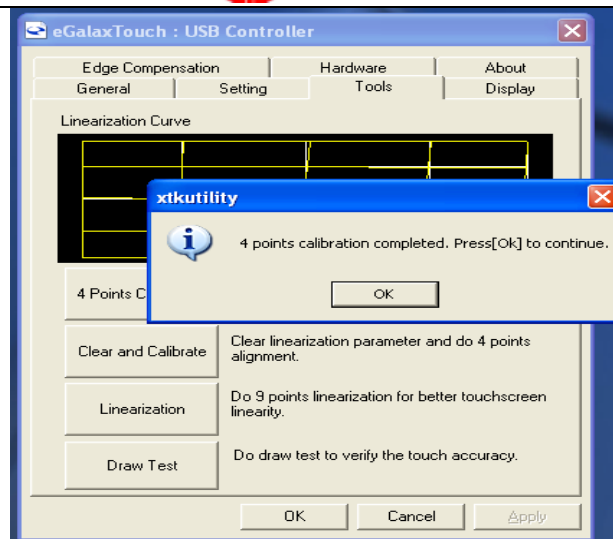

Click [Draw Test], draw by touch pen or finger to determine touch accuracy

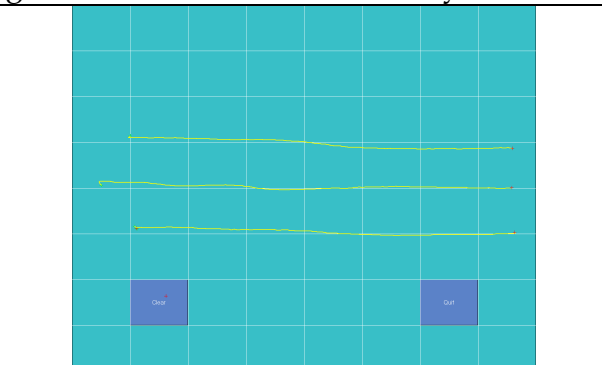
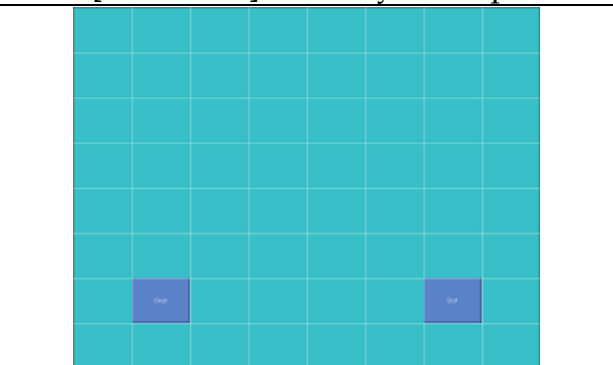

7. Click [Display], you can select the Operation Mode.

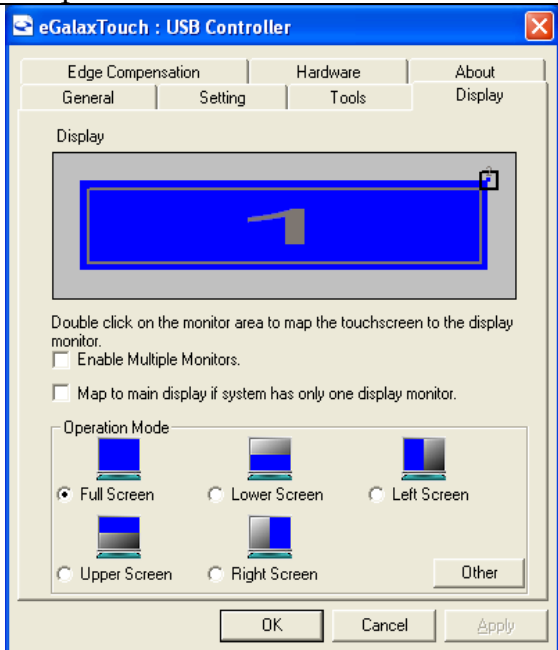

8. Click [Hardware], controller model and firmware version are shown.

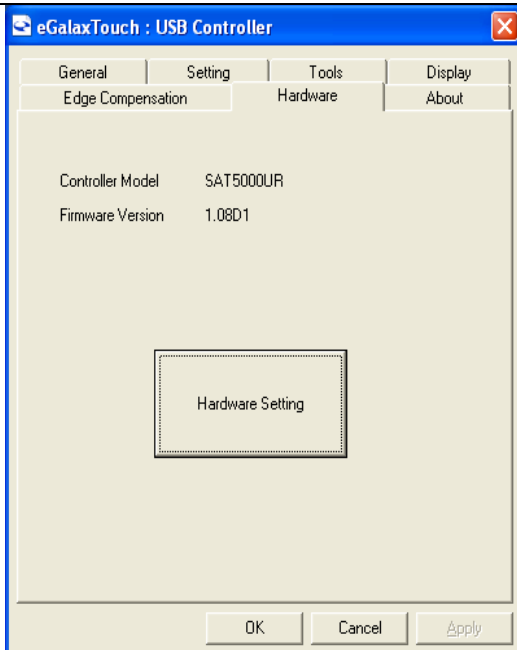

9. Click [Hardware Setting], you can adjust sensitivity and delay time of the touch screen.

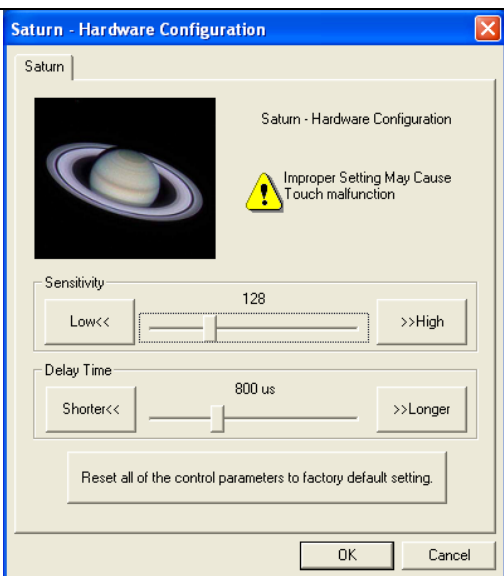

10. Click [Edge Compensation] to adjust the edge parameters.

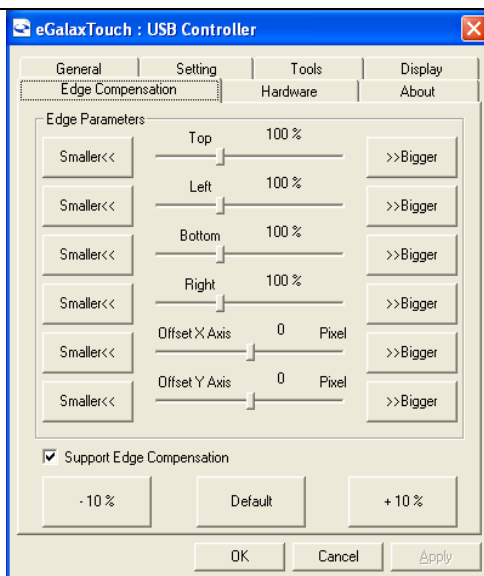

3.3 Light Sensor Function Setting

Facilitated with an ambient light sensor, FUDA2-S1x11 Series Panel PC is capable of automatically adjust panel brightness by sensing light intensity in the surroundings. The sensor can be detected by Windows 7 and Windows 8 without driver installation.
 *Note: This function is enabled as default. It can be disabled under BIOS setting.

Chapter 4

BIOS Setup Information

FUDA2-S1x11 Series Panel PC adopts PEB-99A4 mother board. PEB-99A4 is equipped with the AMI BIOS stored in Flash ROM. These BIOS has a built-in Setup program that allows users to modify the basic system configuration easily. This type of information is stored in CMOS RAM so that it is retained during power-off periods. When system is turned on, PEB-99A4 communicates with peripheral devices and checks its hardware resources against the configuration information stored in the CMOS memory. If any error is detected, or the CMOS parameters need to be initially defined, the diagnostic program will prompt the user to enter the SETUP program. Some errors are significant enough to abort the start up.

4.1 Entering Setup—Launch System Setup

Power on the computer and the system will start POST (Power On Self Test) process. When the message below appears on the screen, press key will enter BIOS setup screen.

Press to enter SETUP

If the message disappears before responding and still wish to enter Setup, please restart the system by turning it OFF and On or pressing the RESET button. It can be also restarted by pressing <Ctrl>, <Alt>, and <Delete> keys on keyboard simultaneously.

Press <F1> to Run General Help or Resume

The BIOS setup program provides a General Help screen. The menu can be easily called up from any menu by pressing <F1>. The Help screen lists all the possible keys to use and the selections for the highlighted item. Press <Esc> to exit the Help screen.

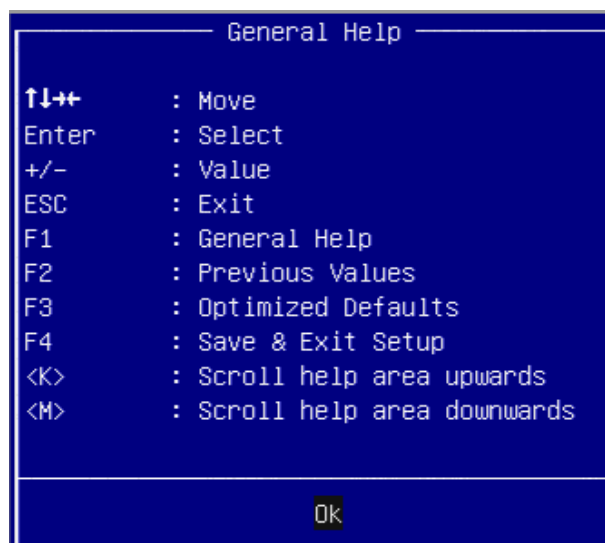

4.2 Main

Use this menu for basic system configurations, such as time, date etc.

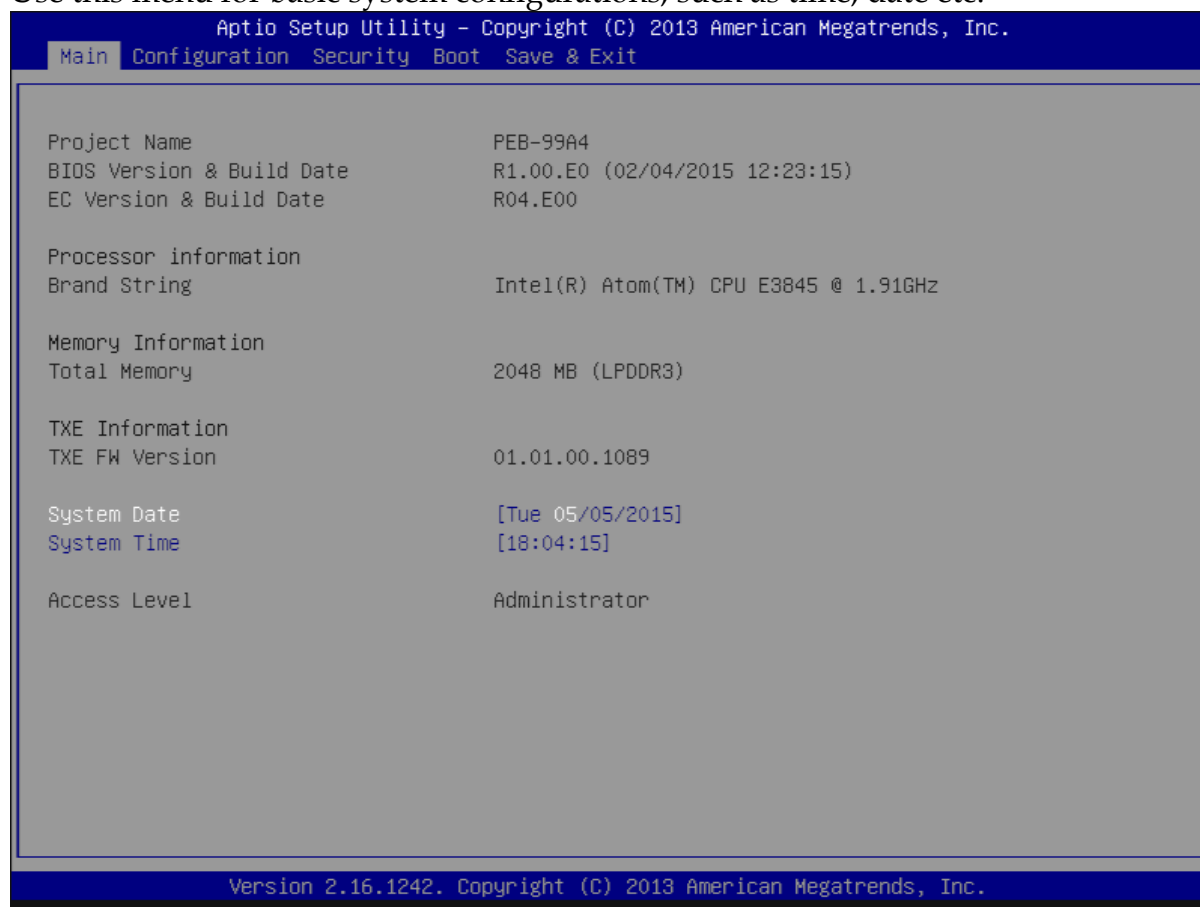

BIOS Information, Memory Information

These items show the firmware and memory specifications of your system. Read only.

System Date

The date format is <Day>, <Month> <Date> <Year>. Use [+] or [-] to configure system Date.

System Time

The time format is <Hour> <Minute> <Second>. Use [+] or [-] to configure system Time.

4.3 Configuration

Use this menu to set up the items of special enhanced features.

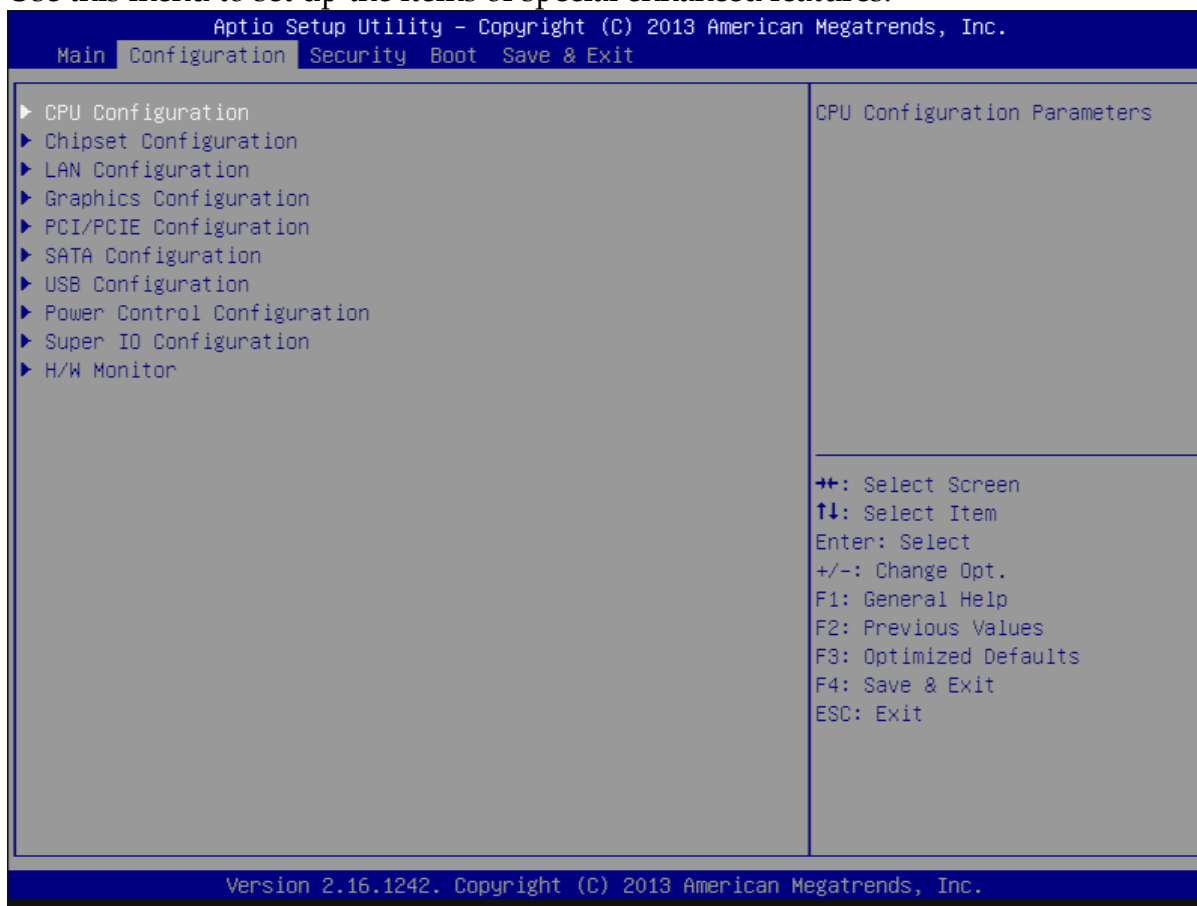

CPU configuration

CPU Configure the specific active core(s) and advanced processor management technologies.

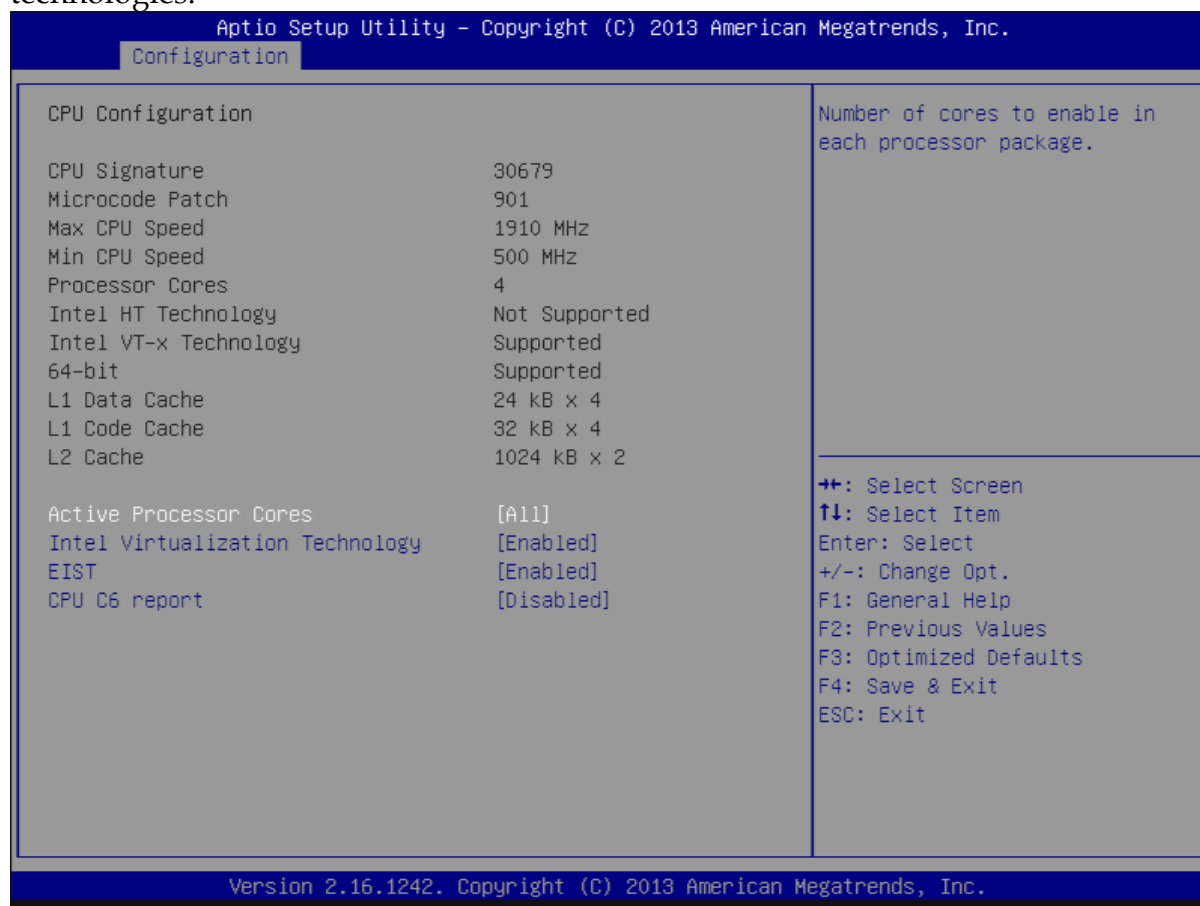

Active Processor Cores

Number of cores to enable in each processor package.

The choice: All(Default), 1.

Intel Virtualization Cores

When enabled, a VMM can utilize the additional hardware capabilities provided by Vander pool Technology.

The choice: Disabled. Enabled(Default).

EIST

Enable/Disable Intel Speed Step.

The choice: Disabled. Enabled(Default).

CPU C6 report

Enable or Disable the CPU C6 (ACPI C3) report to OS.

The choice: Disabled(Default). Enabled.

Chipset Configuration

Configuration Chipset feature.



High Precision Timer

Enable or Disable the High Precision Event Timer.

The choice: Disabled. Enabled(Default).

Audio Controller

Control Detection of the Azalia device. Disabled = Azalia will be unconditionally disabled. Enabled = Azalia will be unconditionally Enabled.

The choice: Disabled. Enabled(Default).

LAN Configuration

Configuration on board LAN device.

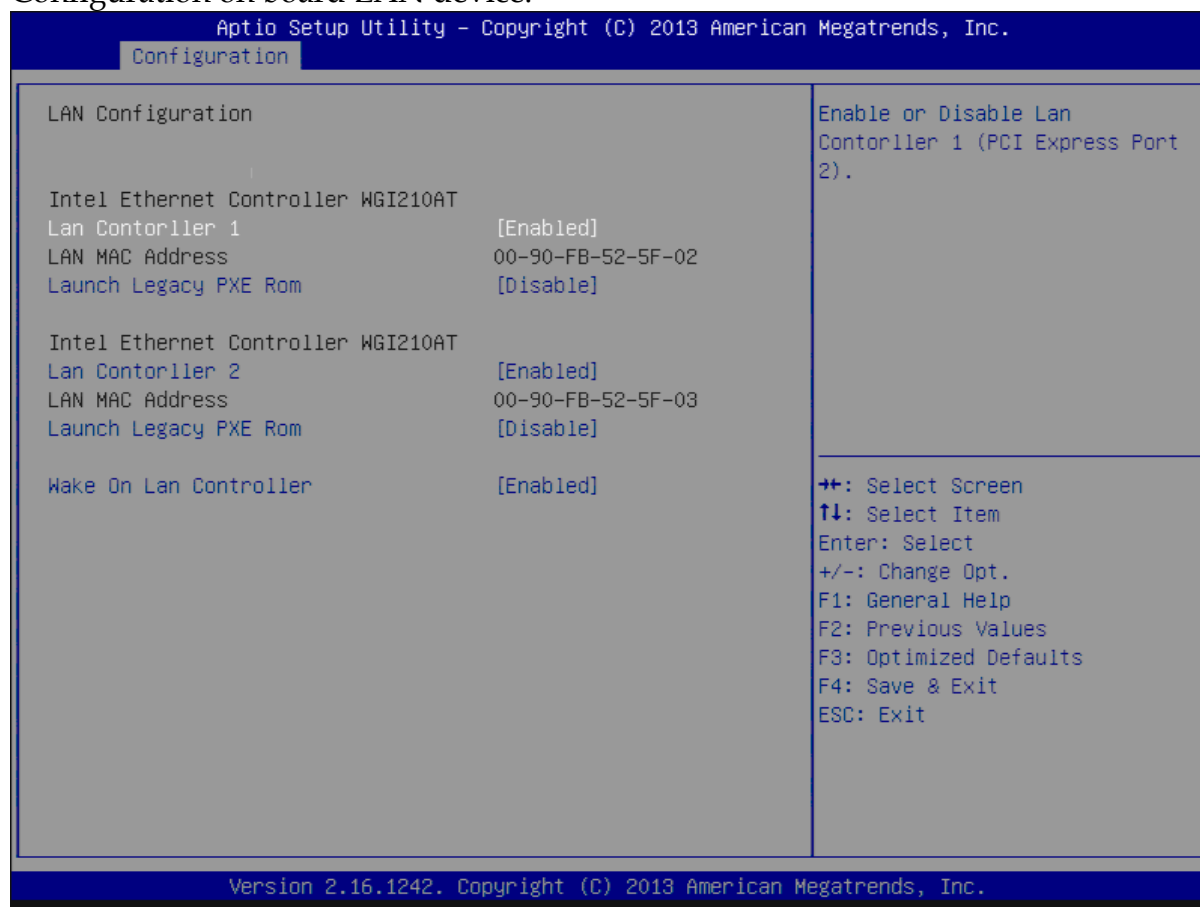

LAN Controller 1

Enable or Disable LAN Controller 1 (PCI Express Port 2).

The choice: Disabled. Enabled(Default).

Launch Legacy PXE Rom

Launch Legacy PXE Rom. [Disable] Not Launch Rom, [Enabled] Force Launch Rom.

The choice: Disabled(Default). Enabled.

LAN Controller 2

Enable or Disable LAN Controller 2 (PCI Express Port 3).

The choice: Disabled. Enabled(Default).

Launch Legacy PXE Rom

Launch Legacy PXE Rom. [Disable] Not Launch Rom, [Enabled] Force Launch Rom.

The choice: Disabled(Default). Enabled.

Wake on LAN Controller

Enable or Disable Intel LAN 0 and Intel LAN 1 WGI210AT wakeup function.

The choice: Disabled. Enabled(Default).

Graphic Configuration

Configure Graphics Setting.

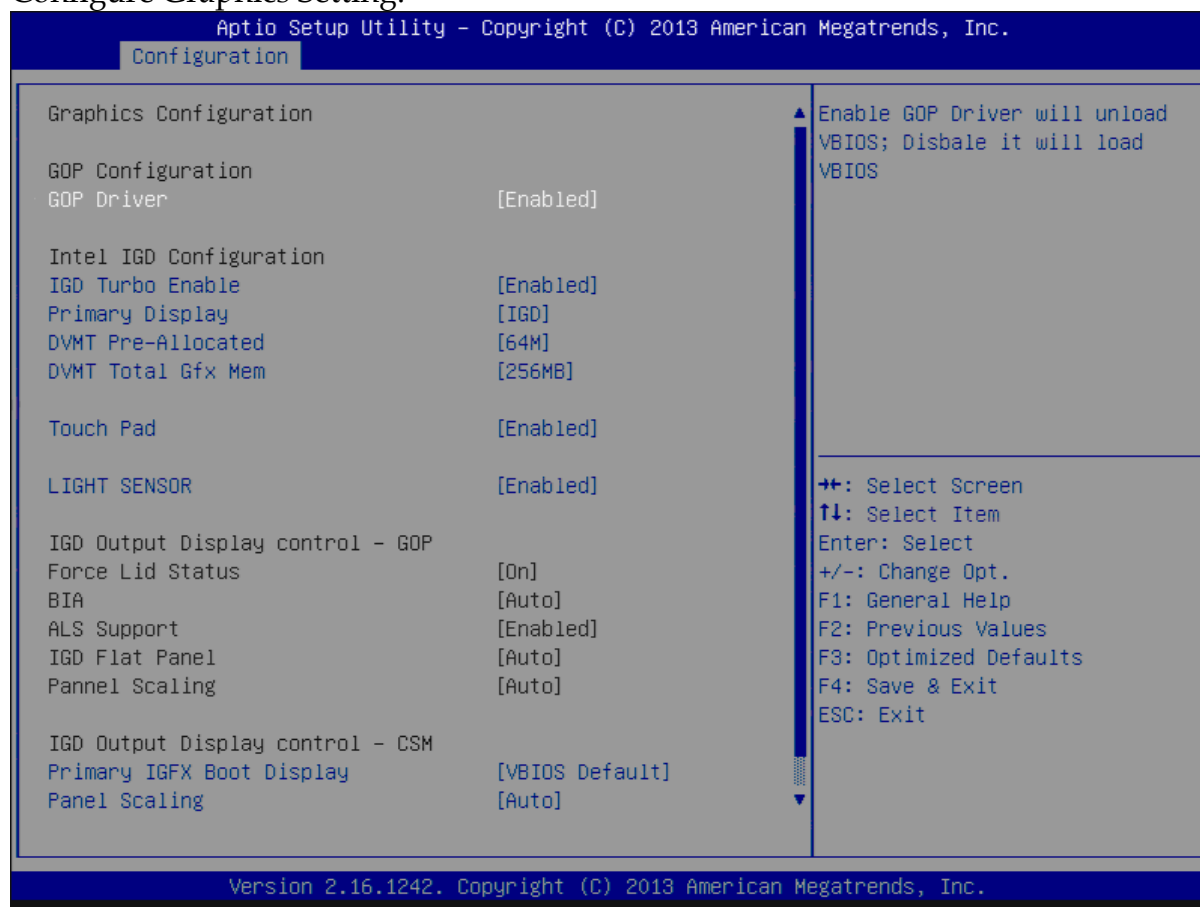

GOP Driver

Enable GOP Driver will unload VBIOS; Disable it will load VBIOS

Choices: Enable(Default), Disable.

IGD Turbo Enable

Enable IGD Turbo Enable; Disable IGD Turbo Disable.

Choices: Enable(Default), Disable.

Primary Display

Select which of IGD/PCI Graphics device should be Primary Display.

Choices: Auto, IGD(Default), PCI, SG.

DVMT Pre-Allocated

Select DVMT 5.0 Pre-Allocated (Fixed) Graphics Memory sized used by the Internal Graphic Device

Choices: 64M(Default), 96M, 128M, 160M, 192M, 224M, 256M, 288M, 320M, 352M, 384M,416M, 448M, 480M, 512M.

DVMT Total GFX Mem

Select DVMT 5.0 Total Graphics Memory sized used by the Internal Graphic Device.

Choices: 128MB, 256MB(Default), Max.

Touch Pad

Touch Pad Enable/Disable.

Choices: Enable(Default), Disable.

LIGHT SENSOR

LIGHT SENSOR Support Enable/Disable..

Choices: Enable(Default), Disable.

Primary IGFX Boot Display

Select the Video Device which will be activated during POST. This as no effect if external graphics present. Secondary will appear based on your Selection. VGA modes will be supported only on primary display.

Choices: VBIOS Default(Default), DVI, LVDS.

Panel Scaling

Select the LCD Panel scaling option used by Internal Graphic device.

Choices: Auto(Default), Off, Force Scaling.

Backlight Control

Back Light Control Setting.

Choices: PWM Inverted, PWM Normal(Default), GMBus Inverted, GMBus Normal.

Active LFP

Select the Active LEP Configuration. Mo LVDS: VBIOS does not enable LVDS. eDP Port-A: LFP driven by Int-DisplayPort encoder from Port-A.

Choices: No LVDS, eDP Port-A(Default).

PCI/PCIE Configuration

PCI, PCI -X and PCI Express Setting.

The screenshot shows the BIOS Configuration screen for PCI/PCIE settings. The title bar reads "Aptio Setup Utility - Copyright (C) 2013 American Megatrends, Inc." and the current screen is labeled "Configuration". The main content area is divided into two columns. The left column is titled "PCI/PCIE Configuration" and contains a sub-menu item "PCI Express Configuration" with a right-pointing arrow. The right column is titled "PCI Express Configuration settings" and is currently empty. Below the settings area, a legend lists the following keyboard shortcuts: ++: Select Screen, ↑↓: Select Item, Enter: Select, +/-: Change Opt., F1: General Help, F2: Previous Values, F3: Optimized Defaults, F4: Save & Exit, and ESC: Exit. The footer of the screen displays "Version 2.16.1242. Copyright (C) 2013 American Megatrends, Inc."

PCI Express Configuration

PCI Express Configuration Setting.

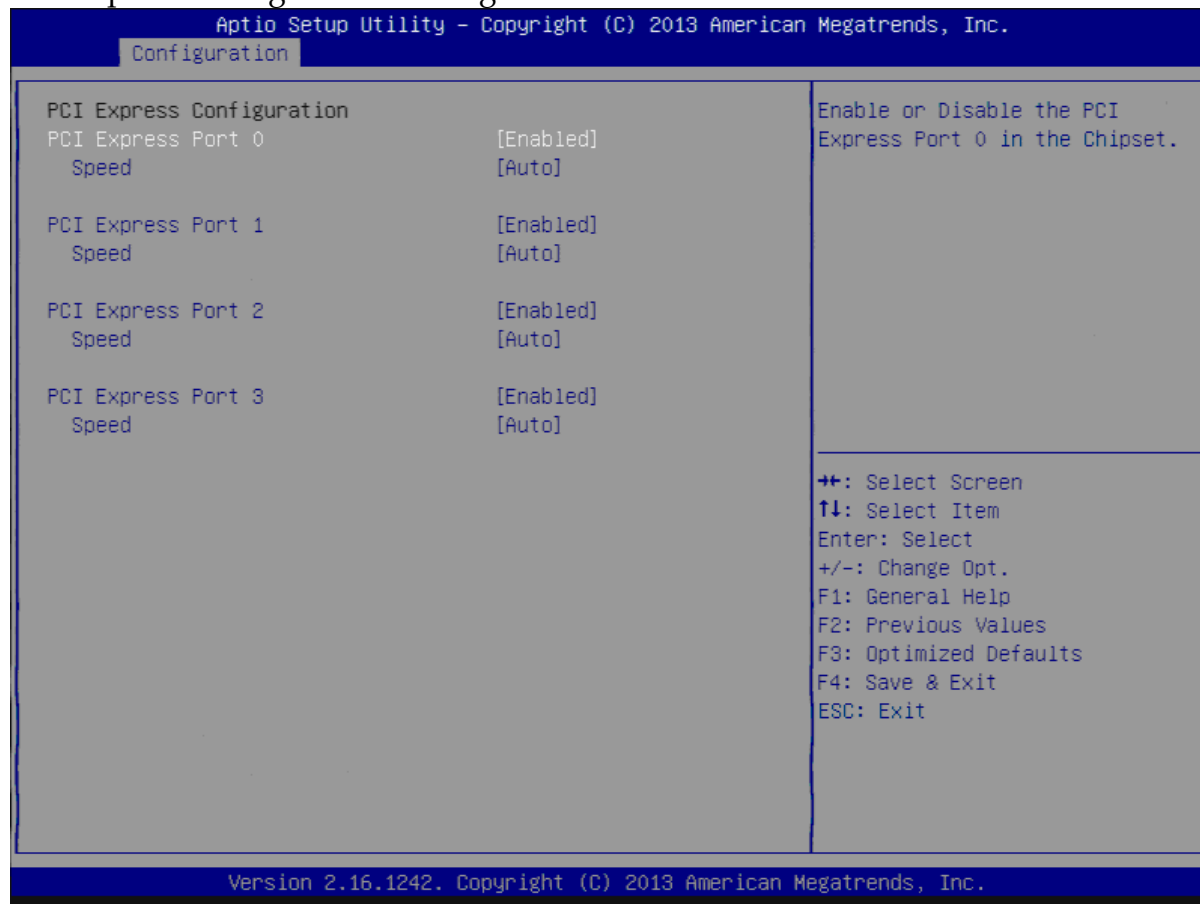

PCI Express Configuration Port 0

Enable or Disable the PCI Express Port 0 in the Chipset.

Choices: Enable(Default), Disable.

Speed

Configuration PCIe Speed

Choices: Auto(Default), Gen1, Gen2.

PCI Express Configuration Port 1

Enable or Disable the PCI Express Port 1 in the Chipset.

Choices: Enable(Default), Disable.

Speed

Configuration PCIe Speed

Choices: Auto(Default), Gen1, Gen2.

PCI Express Configuration Port 2

Enable or Disable the PCI Express Port 2 in the Chipset.

Choices: Enable(Default), Disable.

Speed

Configuration PCIe Speed

Choices: Auto(Default), Gen1, Gen2.

PCI Express Configuration Port 3

Enable or Disable the PCI Express Port 3 in the Chipset.

Choices: Enable(Default), Disable.

Speed

Configuration PCIe Speed

Choices: Auto(Default), Gen1, Gen2.

SATA Configuration

SATA device Options setting.



Serial-ATA (SATA)

Enable or Disable Serial ATA.

Choices: Disabled, Enabled(Default).

SATA Mode

Select IDE / AHCI.

Choices: Disabled, IDE, AHCI(Default).

CF Device

Enabled / Disabled CF Device.

Choices: Disabled, Enabled(Default).

Serial-ATA Port 0

Enable or Disable Serial ATA Port 0.

Choices: Disabled, Enabled(Default).

USB Configuration

USB Configuration Parameters.

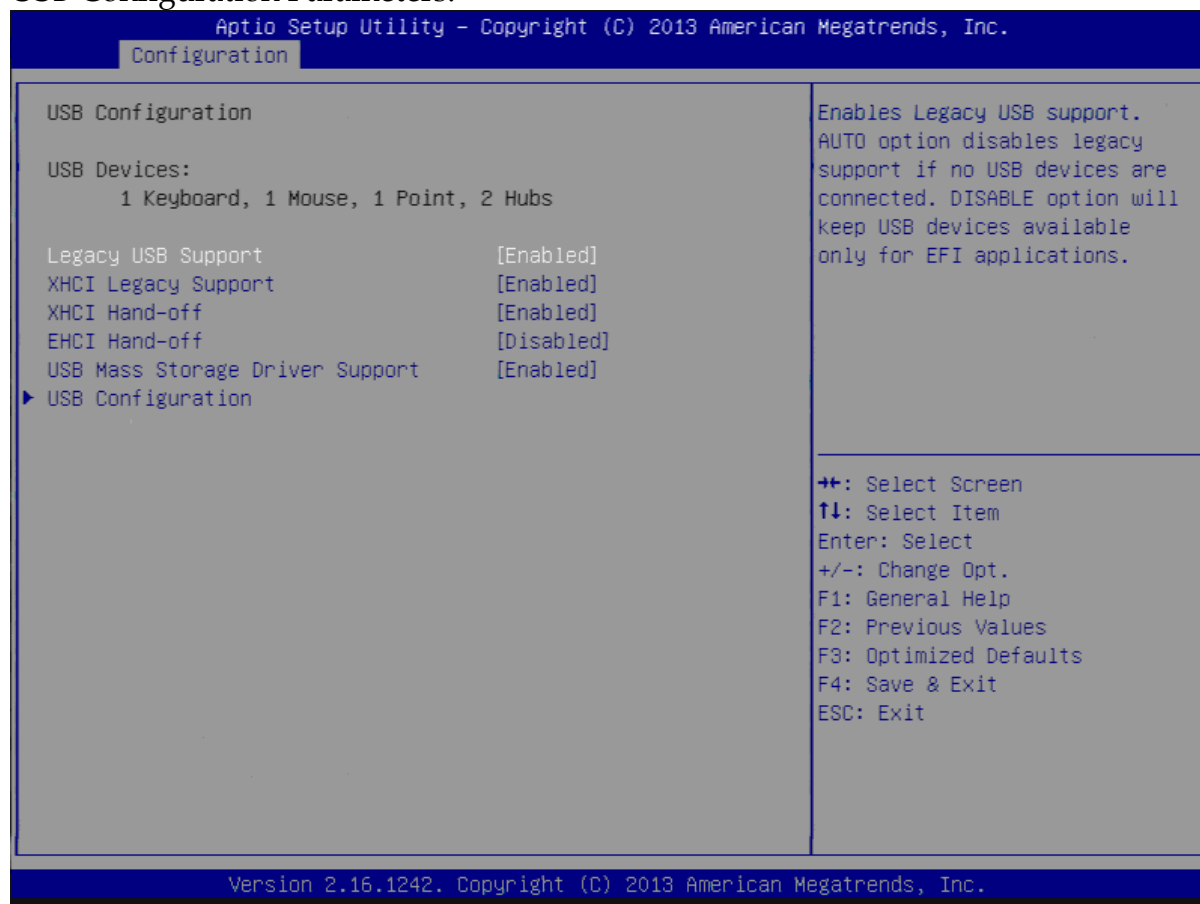

Legacy USB Support

Enables Legacy USB support. AUTO option disables legacy support if no USB devices are connected. DISABLE option will keep USB devices available only for EFI applications.

Choices: Enabled, Disabled(Default).

XHCI Legacy Support

Enable/Disable XHCI Controller Legacy support.

Choices: Enabled, Disabled(Default).

XHCI Hand-off

This is a workaround for Oses without XHCI hand-off support. The XHCI ownership change should be claimed by XHCI driver.

Choices: Enabled, Disabled(Default).

EHCI Hand-off

This is a workaround for Oses without EHCI hand-off support. The EHCI ownership change should be claimed by EHCI driver.

Choices: Enabled, Disabled(Default).

USB Mass storage Driver Support

Enable/Disable USB Mass storage Driver Support.

Choices: Enabled(Default), Disabled.

USB Configuration

USB Configuration settings.



XHCI Mode

Mode of operation of XHCI controller

Choices: Smart Auto(Default), Auto, Enable, Disable.

USB2 Link Power Management

Enable/Disable USB2 Link Power Management.

Choices: Enable(Default), Disable.

USB 2.0 (EHCI) Support

Control the USB EHCI (USB2.0) functions. One EHCI controller must always be enabled.

Choices: Enable, Disable(Default).

USB Port 0

Enable/Disable USB Port 0: USB 3.0 port on Board.

Choices: Enable(Default), Disable.

USB Port 1

Enable/Disable USB Port 1: USB 2.0 port on Board.

Choices: Enable(Default), Disable.

USB Port 2

Enable/Disable USB Port 2: The USB port turn into a mini PCIE.

Choices: Enable(Default), Disable.

USB Port 3

Enable/Disable USB Port 3: The USB port as USB HUB have 2 USB Port in external cart.

Choices: Enable(Default), Disable.

Power Control Configuration

System Power Control Configuration Parameters.



Enable Hibernation

Enable or disable System ability to Hibernate (OS/S4 Sleep State). This option may be not effective with some OS.

Choices: Disabled, Enabled(Default).

ACPI Sleep State

Select the highest ACPI sleep state the system will enter when the SUSPEND button is pressed.

Choices: Suspend Disable, S3 (Suspend to RAM) (Default)

Restore AC Ring Loss

Select AC Power state when power is re-applied after a power failure.

Choices: Power Off, Power on, Last State(Default).

Wake on Ring Controller

Enable / Disable GPIO wake on Ring function.

Choices: Disabled(Default), Enabled.

Wake System from S5

Enable or Disable System wake on alarm event, Select Enable, system will wake on the hr: mm: sec: specified.

Choices: Disabled(Default), Enabled.

Super IO Configuration

System Super IO Chip Parameters.

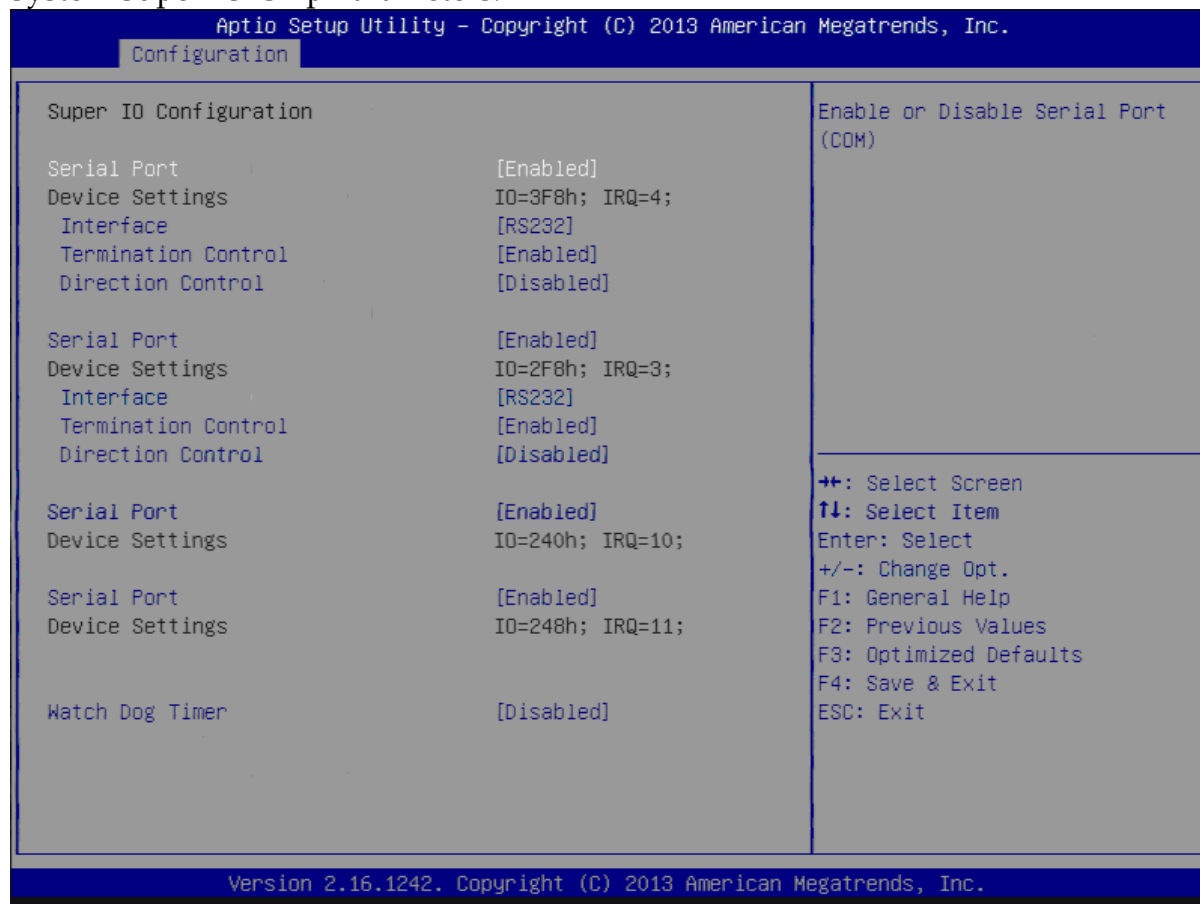

Serial Port

Enable or Disable Serial Port (COM) IO=3F8H; IRQ=4.

Choices: Disabled, Enabled(Default).

Interface

Set Current UART mode RS232, RS485, RS485/RS422.

Choices: RS232(Default), RS485 HALF DUFLEX, RS485/422 FULL DUFLEX.

Termination Control

Set Termination Control Disabled/ Enabled.

Choices: Disabled, Enabled(Default).

Direction Control

Set Direction Control set Enabled as Transceiver else; Disabled as Receiver.

Choices: Disabled(Default), Enabled.

Serial Port

Enable or Disable Serial Port (COM) IO=2F8H; IRQ=3.

Choices: Disabled, Enabled(Default).

Interface

Set Current UART mode RS232, RS485, RS485/RS422.

Choices: RS232(Default), RS485 HALF DUFLEX, RS485/422 FULL DUFLEX.

Termination Control

Set Termination Control Disabled/ Enabled.

Choices: Disabled, Enabled(Default).

Direction Control

Set Direction Control set Enabled as Transceiver else; Disabled as Receiver.

Choices: Disabled(Default), Enabled.

Serial Port

Enable or Disable Serial Port (COM) IO=240H; IRQ=10.

Choices: Disabled, Enabled(Default).

Serial Port

Enable or Disable Serial Port (COM) IO=248H; IRQ=11.

Choices: Disabled, Enabled(Default).

Watch Dog Timer

Enable or Disable Watch Dog Timer.

Choices: Disabled(Default), Enabled.

Timer Unit (Watch Dog Timer Enabled)

Select Timer count unit of WDT.

Choices: Seconds(Default), Minutes.

Timer value (Watch Dog Timer Enabled)

Set WDT Timer value Seconds/minutes.

Choices: Default [20].

Hardware Monitor

Monitor hardware status.

Aptio Setup Utility - Copyright (C) 2013 American Megatrends, Inc.

Configuration

Health Status	
CPU temperature	: +45 C
System temperature	: +36 C
Vcore	: +0.924 V
+3.3V	: +3.378 V
+5V	: +5.193 V
+12V	: +12.612 V
+1.35V	: +1.359 V

++: Select Screen
 ↑↓: Select Item
 Enter: Select
 +/-: Change Opt.
 F1: General Help
 F2: Previous Values
 F3: Optimized Defaults
 F4: Save & Exit
 ESC: Exit

Version 2.16.1242. Copyright (C) 2013 American Megatrends, Inc.

4.4 Security

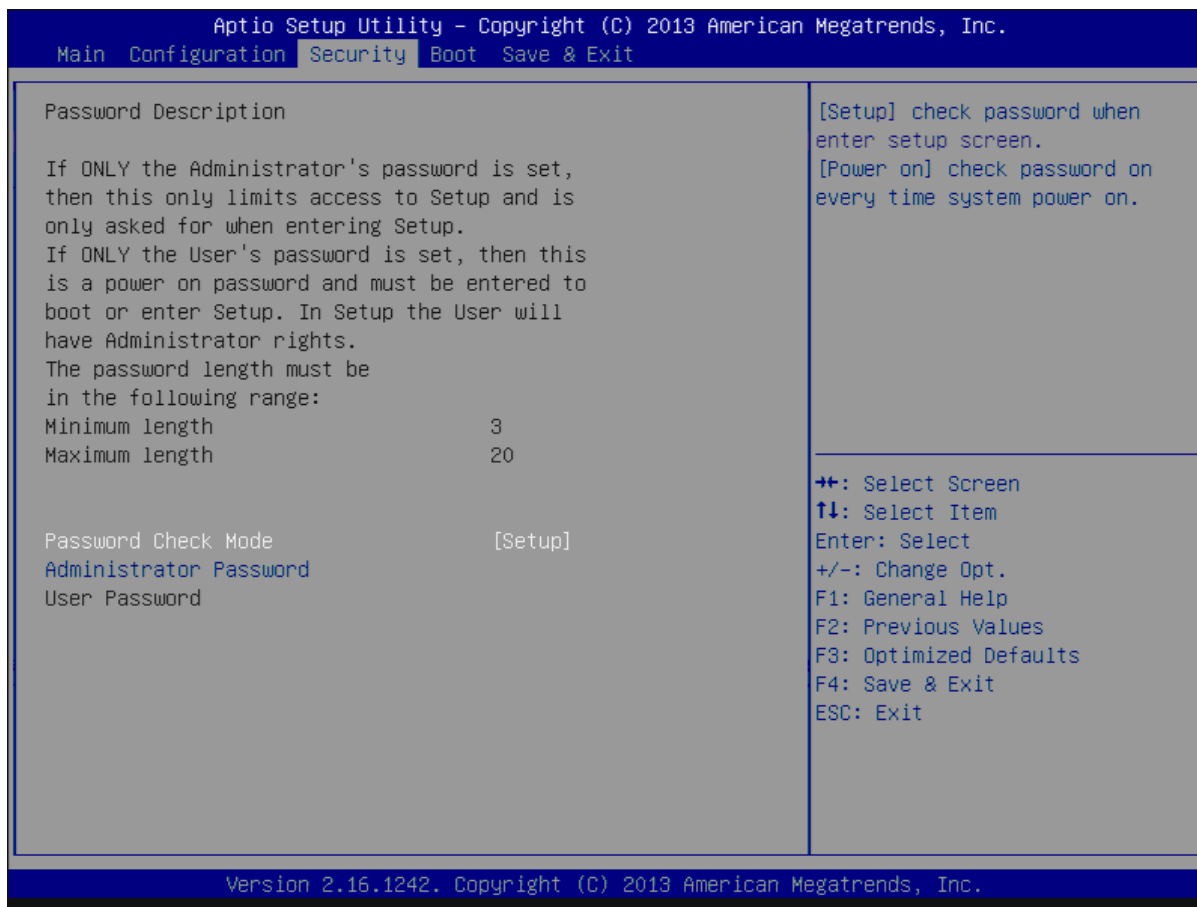

Password Check Mode

[Setup] check password when enter setup screen, [Power On] check password on every time system power on.

Choices: Setup(Default), Power On.

Administrator Password

Set Administrator Password

User Password

Set User Password.

4.5 Boot

Use this menu to specify the priority of boot devices.

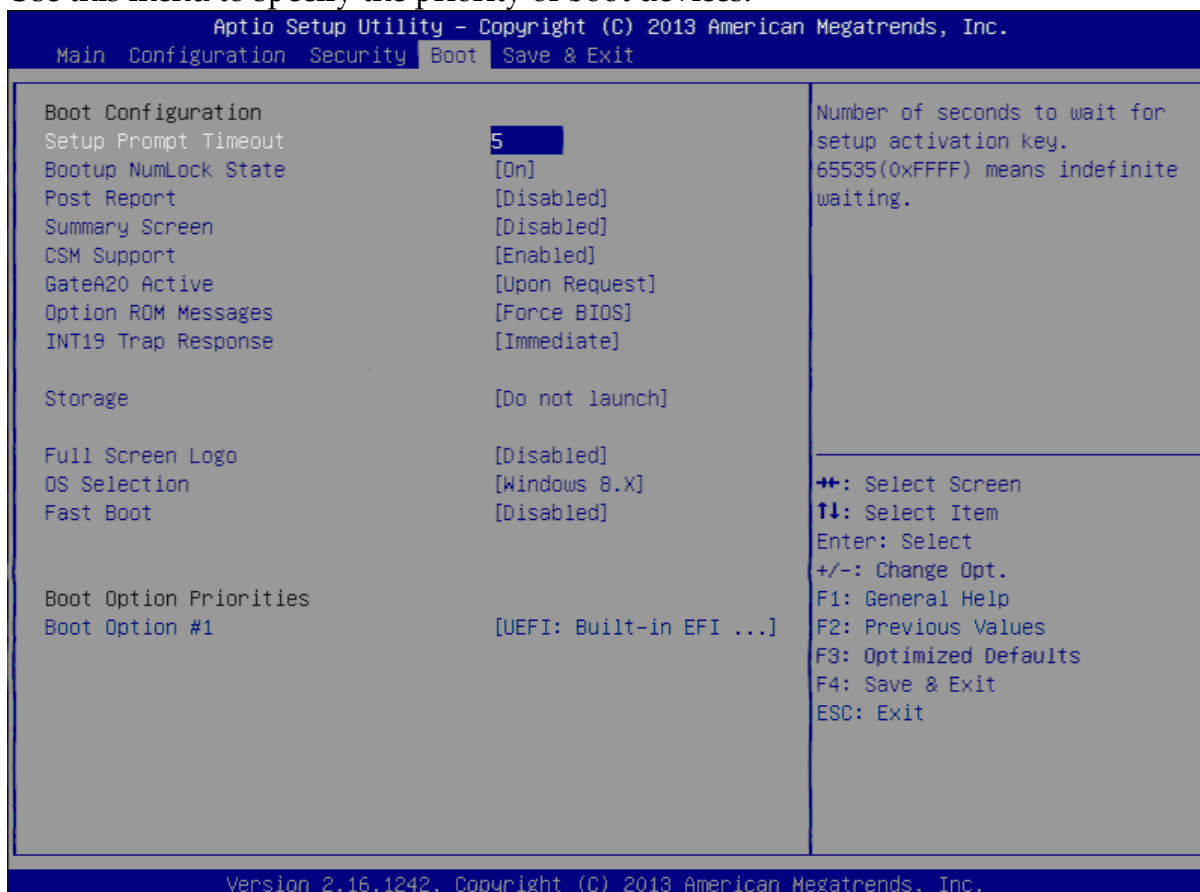

Setup Prompt Timeout

Number of seconds to wait for setup activation key. 65535 (0xFFFF) means indefinite waiting.

Choices: Default [5].

Bootup NumLock state

Select the keyboard NumLock state.

Choices: On(Default), Off.

Post Report

Post Report Support Enabled/Disabled.

Choices: Disabled(Default), Enabled.

Summary Screen

Summary Screen Support Enabled/Disabled.

Choices: Disabled(Default), Enabled.

CSM Support

Enabled/Disabled CSM Support.

Choices: Disabled, Enabled(Default).

GateA20 Active

UPON REQUEST - GA20 can be disabled using BIOS services. ALWAYS - do not allow disabling GA20; this option is useful when any RT code is executed above 1MB.

Choices: Upon Request(Default), Always.

Option ROM Messages

Set display mode for Option ROM.

Choices: Force BIOS(Default), Keep Current.

INT19 Trap Response

BIOS reaction on INT19 trapping by Option ROM: IMMEDIATE - execute the trap right away; POSTPONED - execute the trap during legacy boot.

Choices: Immediate(Default), Postponed.

Storage

Controls the of execution of UEFI and Legacy Storage OpROM.

Choices: Do not launch(Default), UEFI only, Legacy only.

Full Screen Logo

Enables or Disables Quiet Boot option and Full screen Logo.

Choices: Disabled(Default), Enabled.

OS Selection

OS Selection

Choices: Windows 8.X(Default), Windows 7.

Fast Boot

Enables or Disables boot with initialization of a minimal set of devices required to launch active boot option. Has no effect for BBS boot options.

Choices: Disable(Default), Enabled.

Boot Option #1

Sets the system boot order

Choices: UEFI: Built-in EFI Shell, Disabled.

4.6 Save and Exit

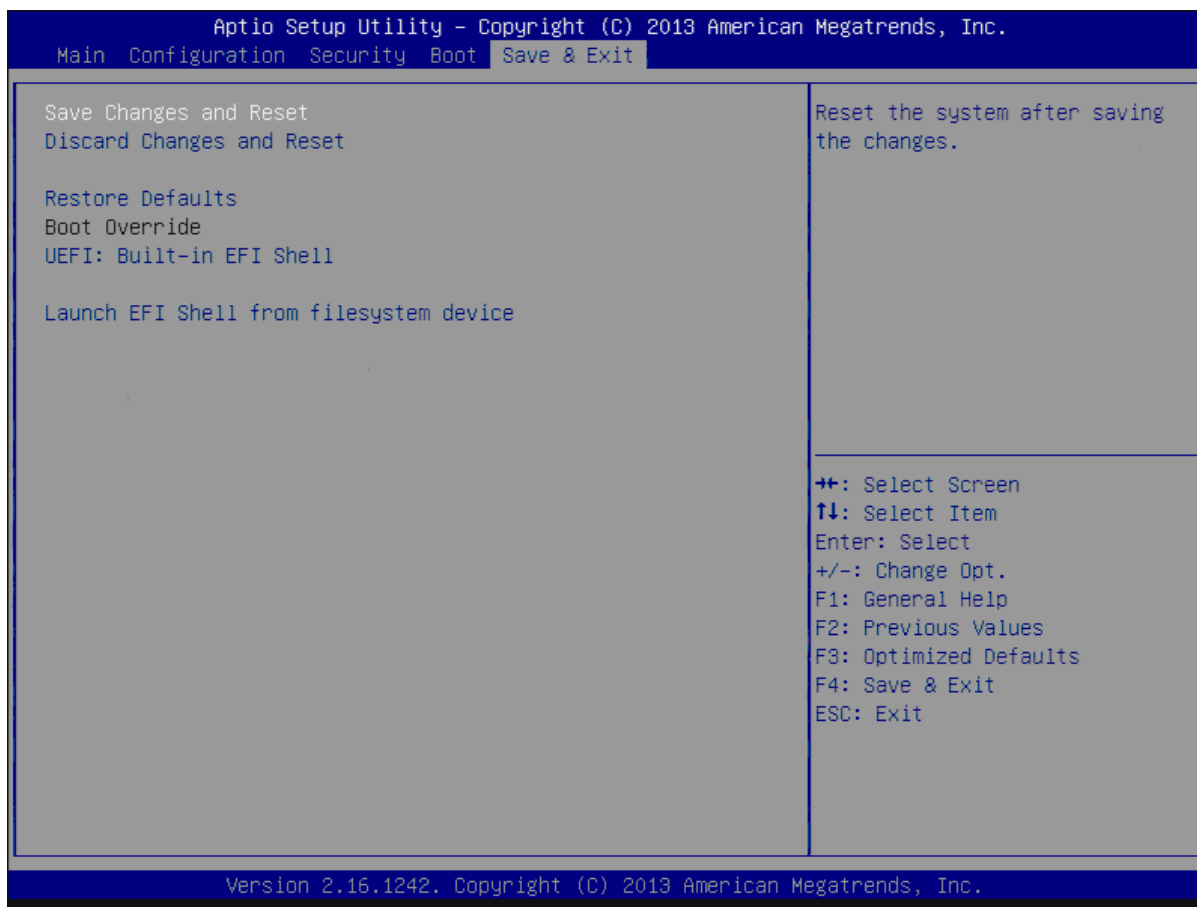

Save Changes and Reset

Reset the system after saving the changes.

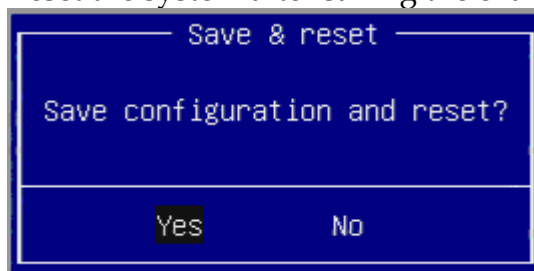

Pressing <Enter> on this item asks for confirmation: Save configuration and reset.

Discard Changes and Exit

Reset system setup without saving any changes.

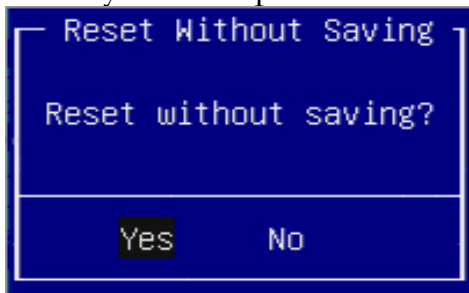

Pressing <Enter> on this item asks for confirmation: Reset without saving.

Restore Defaults

Restore/Load Default values for all the setup options.

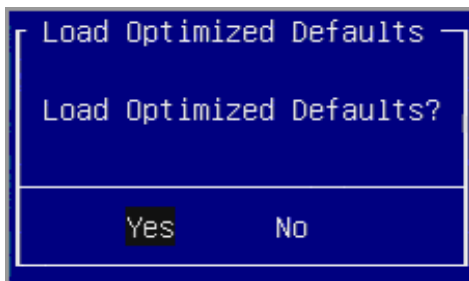

Pressing <Enter> on this item asks for confirmation: Load Optimized Default.

Chapter 5

Important Instructions

This chapter includes instructions which must be carefully followed when the fan-less embedded system is used.

5.1 Note on the Warranty

Due to their limited service life, parts which, by their nature, are especially subject to wear are not included in the guarantee beyond the legal stipulations.

5.2 Exclusion of Accident Liability Obligation

Portwell, Inc. shall be exempt from the statutory accident liability obligation if users fail to abide by the safety instructions.

5.3 Liability Limitations / Exemption from the Warranty Obligation

In the event of damage to the system unit caused by failure to abide by the hints in this manual and on the unit (especially the safety instructions), Portwell, Inc. shall not be required to respect the warranty even during the warranty period and shall be free from the statutory accident liability obligation.

5.4 Declaration of Conformity

EMC

CE/FCC Class A

This equipment complies with Part 15 of the FCC Rules. Operation is subject to the following two conditions:

1. This equipment may not cause harmful interference.
2. This equipment must accept any interference that may cause undesired operation.

Applicable Standards:

EN 55022: 2006 + A1: 2007, Class A

EN 61000-3-2: 2006

EN 61000-3-3: 1995 + A1: 2001 + A2: 2005

EN 55024: 1998 + A1: 2001 + A2: 2003

IEC 61000-4-2: 2008

IEC 61000-4-3: 2006 + A1: 2007

IEC 61000-4-4: 2004

IEC 61000-4-5: 2005

IEC 61000-4-6: 2007

IEC 61000-4-8: 1993 + A1: 2000

IEC 61000-4-11: 2004

FCC 47 CFR Part 15 Subpart

Chapter 6 Frequent Asked Questions

Q1: What materials can be applied on the touch screen of Panel PC?

Answer:

Chemical item	Oil item	General item
Acetone	Water-white mineral oil	Ammonia cleanser
Butanone	Unlead gasoline	Clothing cleanser
Isopropanol	Diedel fuel	Vinegar
Hexane	Engine oil	Coffee
Turpentine	Speed change oil	Tea
Methanol	Antibreeze	Animalistic fat
		Normal Saline
		Salad oil

Q2: How to enable/disable Light Sensor function in Windows 7?

Answer:

Light Sensor function can be turned on/off in Windows 7.

Step 1: Open "Control Panel"

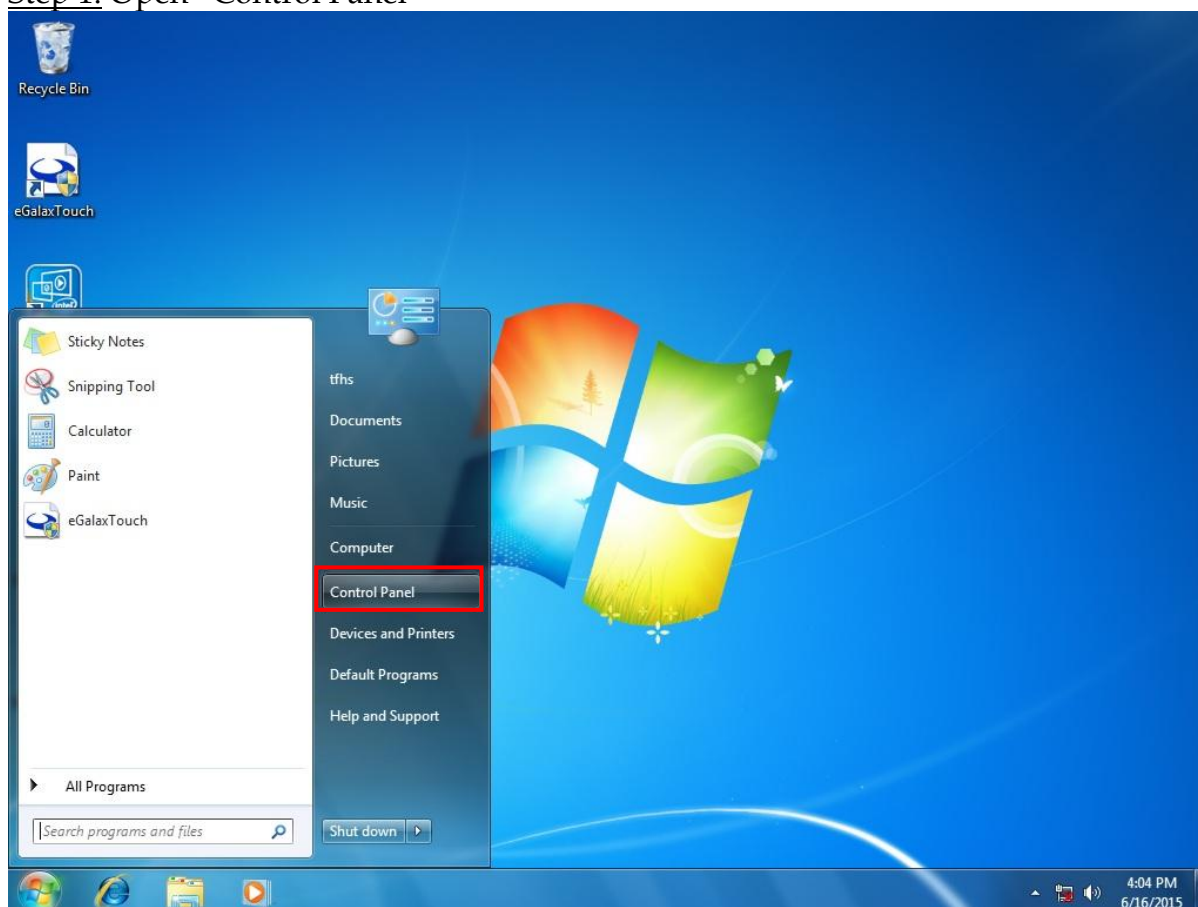

Step 2: Select “Location and Other Sensors”

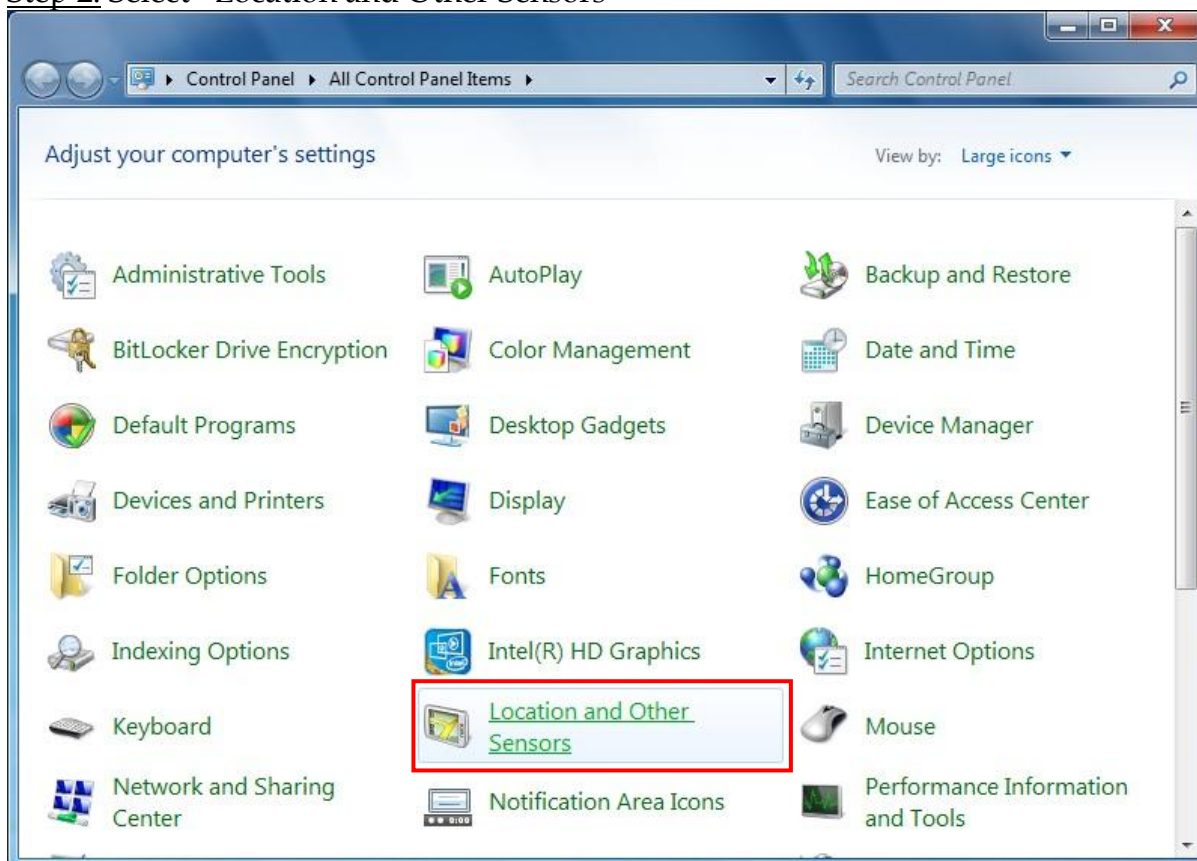

Step 3: Check and Apply to enable/disable Light Sensor function.

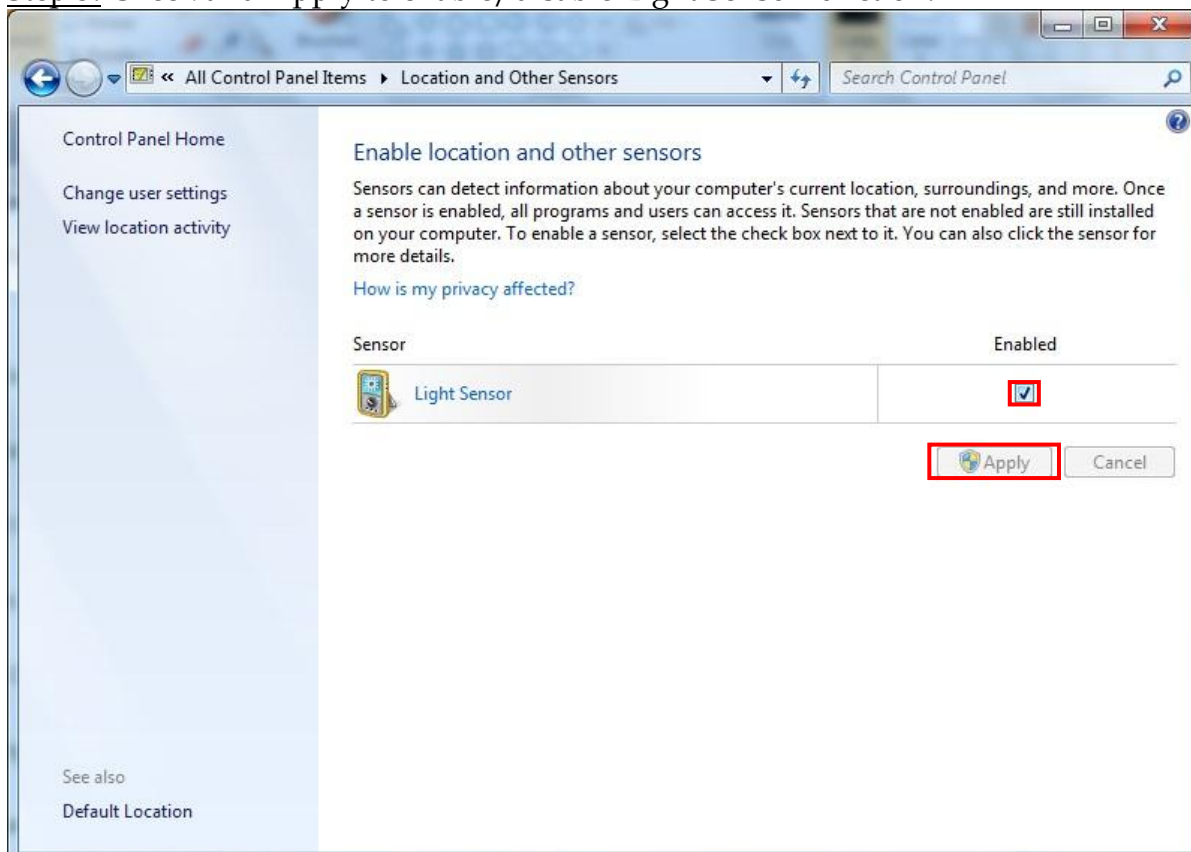

Q3: How to set OS Selection for different OS?

Answer:

You can find OS Selection under BIOS setting.

Step1. Power on the computer and the system will start POST (Power on Self Test) process. When the message appears on the screen, press key and enter BIOS setup screen.

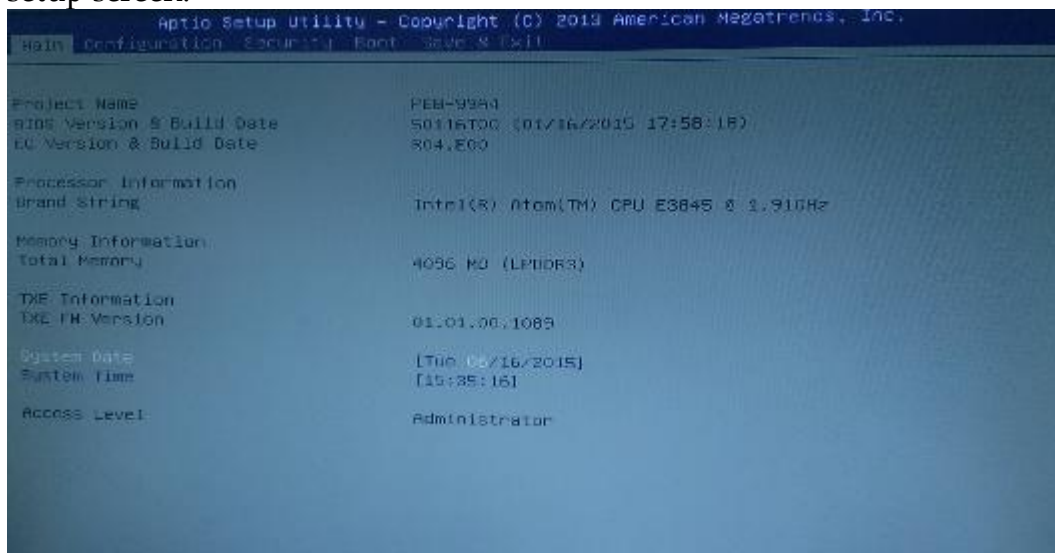

Step2. In page "Boot", you can find OS Selection and choose the corresponding OS.
Note: For Linux OS, please choose Windows 7.

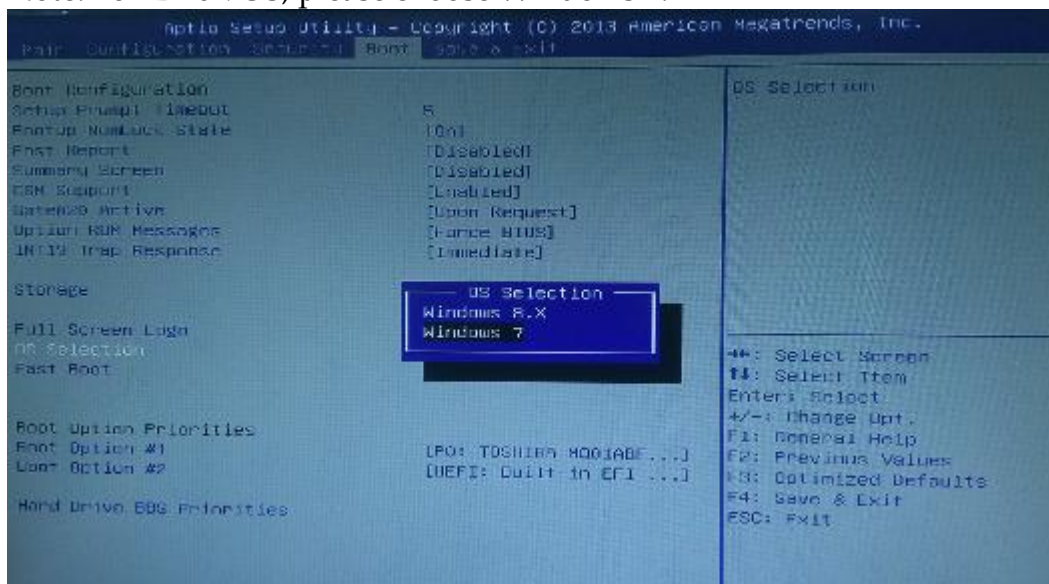

Q4: What supposed to do when forget the password of system BIOS?

Answer:

Please turn off the power supply, and then find the JP1 to set it from 1-2 short to 2-3 short. Wait for 5 seconds to clean password; then set it back to 1-2 short to turn on power supply.

JP1: CMOS Setup

PIN NO.	DESCRIPTION
1-2	Normal (Keep CMOS Setup) ★ Default
2-3	Clear CMOS Setup

Q5: How to set AT mode for the system?

Answer:

The default setting is ATX mode: user needs to press the power button in order to turn on the system. By adjusting SW2 port 1 jumper on board and restart the system, user can set the system as AT mode.

SW2: AT/ATX & BIOS recovery Setup

PIN NO.	DESCRIPTION
1-4(Port1)	ON: AT Mode OFF:ATX Mode ★ Default

*Note: Diagram ATX mode setting

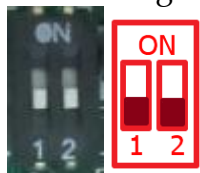

*Note: Diagram AT mode setting

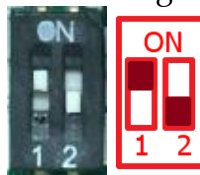

Q6: How to update BIOS?

Answer:

Please follow procedures below step by step.

Step1. Execute the “Update.zip” file to root of the bootable USB pen drive. You can get the “Update.efi” and “Readme.txt” two files.

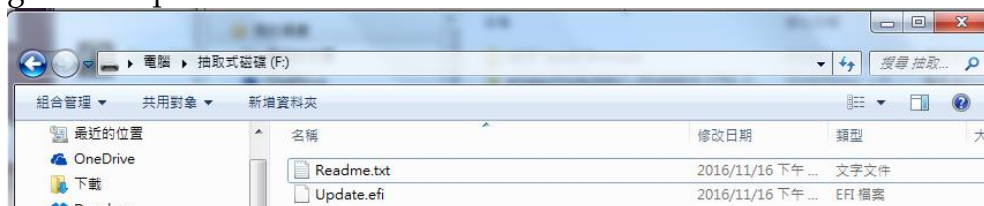

Step2. Insert your USB pen drive in USB port of the FUDA2-S1x21 Series Panel PC and press the power button to power on.

Step3. Press key during the POST (Power On Self Test) process will enter BIOS setup screen.

Step4. Boot to EFI-Shell mode by choosing below item.

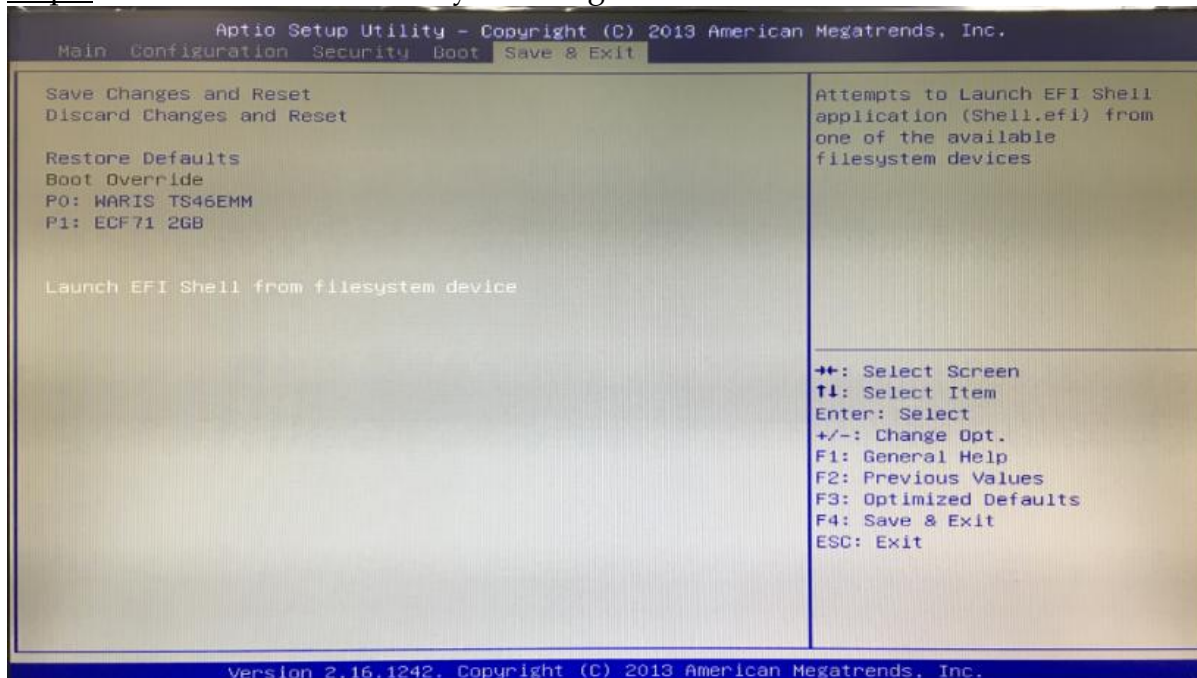

Step5. Type “map -r” command to show the mapping table and find the right location of removable USB pen driver. (in this case is the right location is “fs3”)

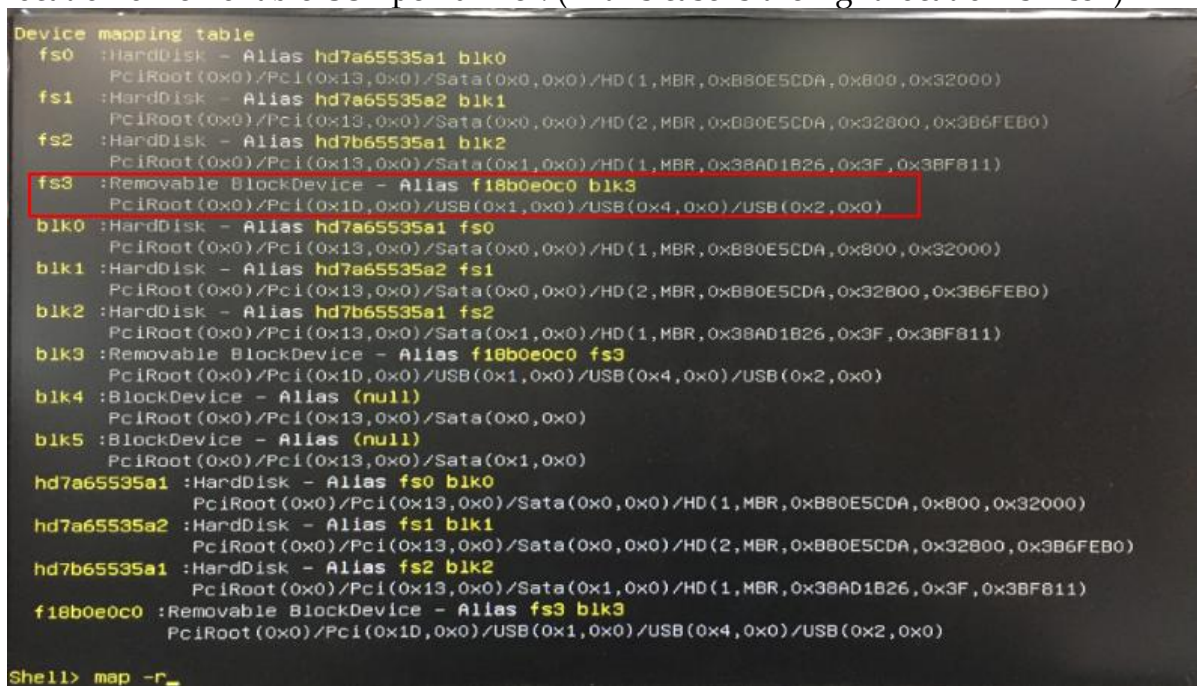

Step6. Type “fs3:” command to switch to the root of the USB pen drive. And type “dir” to find the directory of fs3.

```

blk3 :Removable BlockDevice - Alias f18b0e0c0 fs3
      PciRoot(0x0)/Pci(0x1D,0x0)/USB(0x1,0x0)/USB(0x4,0x0)/USB(0x2,0x0)
blk4 :BlockDevice - Alias (null)
      PciRoot(0x0)/Pci(0x13,0x0)/Sata(0x0,0x0)
blk5 :BlockDevice - Alias (null)
      PciRoot(0x0)/Pci(0x13,0x0)/Sata(0x1,0x0)
hd7a65535a1 :HardDisk - Alias fs0 blk0
            PciRoot(0x0)/Pci(0x13,0x0)/Sata(0x0,0x0)/HD(1,MBR,0xB80E5CDA,0x800,0x32000)
hd7a65535a2 :HardDisk - Alias fs1 blk1
            PciRoot(0x0)/Pci(0x13,0x0)/Sata(0x0,0x0)/HD(2,MBR,0xB80E5CDA,0x32800,0x3B6FEB0)
hd7b65535a1 :HardDisk - Alias fs2 blk2
            PciRoot(0x0)/Pci(0x13,0x0)/Sata(0x1,0x0)/HD(1,MBR,0x38AD1B26,0x3F,0x3BF811)
f18b0e0c0 :Removable BlockDevice - Alias fs3 blk3
          PciRoot(0x0)/Pci(0x1D,0x0)/USB(0x1,0x0)/USB(0x4,0x0)/USB(0x2,0x0)

Shell> fs3:
fs3:\> dir
Directory of: fs3:\

11/16/16 08:21p          370  Readme.txt
11/16/16 08:21p    4,426,915  Update.efi
    
```

Step7. Type the “update” command to start flash BIOS processes.

```

fs3:\> update
=====
= Start update procedure =
=
= UEFI Unpacker v1.1<F> =
=====
> Unpacking package ....DONE
> Ready to Update BIOS ....
    
```

Step8. Press “Ctrl+Alt+Del” to reboot when it finish all update process.

Q7: How to enable/disable light sensor function in Windows 10?

Answer:

Please set LIGHT SENSOR as “Disable” in BIOS setting.

